Parallel Processing

WS 2017/18

Roland Wismüller
Universität Siegen
roland.wismueller@uni-siegen.de
Tel.: 0271/740-4050, Büro: H-B 8404

Stand: January 23, 2018

Parallel Processing

WS 2017/18

5 Appendix

Parallel Processing

WS 2017/18

26.10.2017

Roland Wismüller
Universität Siegen
roland.wismueller@uni-siegen.de
Tel.: 0271/740-4050, Büro: H-B 8404

Stand: January 23, 2018



5.1.1 Fundamentals of C++

- ➔ Commonalities between C++ and Java:
 - ➔ imperative programming language
 - ➔ syntax is mostly identical
- ➔ Differences between C++ and Java:
 - ➔ C++ is not purely object oriented
 - ➔ C++ programs are translated directly to machine code (no virtual machine)
- ➔ Usual file structure of C++ programs:
 - ➔ header files (*.h) contain declarations
 - ➔ types, classes, constants, ...
 - ➔ source files (*.cpp) contain implementations
 - ➔ methods, functions, global variables

Compilation of C++ programs

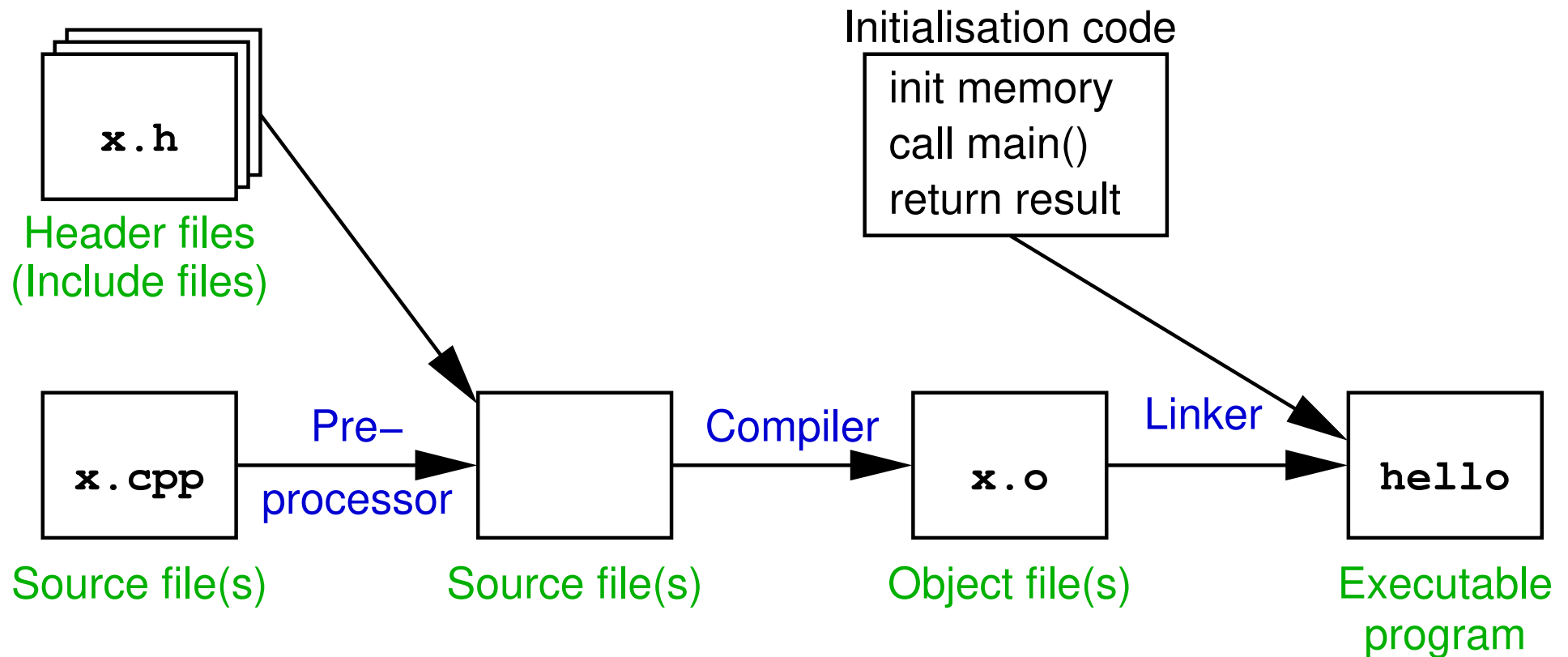

- ➔ Preprocessor: embedding of files, expansion of macros
- ➔ Linker: binds together object files and libraries



Compilation of C++ programs ...

- ➔ Invocation of the compiler in the lab room H-A 4111:
 - ➔ `g++ -Wall -o <output-file> <source-files>`
 - ➔ executes preprocessor, compiler and linker
 - ➔ `-Wall`: report all warnings
 - ➔ `-o <output-file>`: name of the executable file
- ➔ Additional options:
 - ➔ `-g`: enable source code debugging
 - ➔ `-O`: enable code optimization
 - ➔ `-l<library>`: link the given library
 - ➔ `-c`: do not execute the linker
 - ➔ later: `g++ -o <output-file> <object-files>`



An example: *Hello World!* (👉 05/hello.cpp)

```
#include <iostream>
```

Preprocessor directive: inserts contents of file 'iostream' (e.g., declaration of cout)

```
using namespace std;
```

Use the namespace 'std'

```
void sayHello()
```

Function definition

```
{  
    cout << "Hello World\n";  
}
```

Output of a text

```
int main()
```

Main program

```
{  
    sayHello();  
    return 0;  
}
```

Return from main program:
0 = OK, 1,2,...,255: error

➔ Compilation: `g++ -Wall -o hello hello.cpp`

➔ Start: `./hello`



Syntax

- ➔ Identical to Java are among others:
 - ➔ declaration of variables and parameters
 - ➔ method calls
 - ➔ control statements (if, while, for, case, return, ...)
 - ➔ simple data types (short, int, double, char, void, ...)
 - ➔ deviations: `bool` instead of `boolean`; `char` has a size of 1 Byte
 - ➔ virtually all operators (+, *, %, <<, ==, ?:, ...)
- ➔ Very similar to Java are:
 - ➔ arrays
 - ➔ class declarations



Arrays

➔ Declaration of arrays

➔ only with fixed size, e.g.:

```
int ary1[10]; // int array with 10 elements
```

```
double ary2[100][200]; // 100 * 200 array
```

```
int ary3[] = { 1, 2 }; // int array with 2 elements
```

➔ for parameters: size can be omitted for **first** dimension

```
int funct(int ary1[], double ary2[][200]) { ... }
```

➔ Arrays can also be realized via pointers (see later)

➔ then also dynamic allocation is possible

➔ Access to array elements

➔ like in Java, e.g.: `a[i][j] = b[i] * c[i+1][j];`

➔ but: **no** checking of array bounds!!!



Classes and objects

➔ Declaration of classes (typically in .h file):

```
class Example {  
    private:                // private attributes/methods  
        int attr1;           // attribute  
        void pmeth(double d); // method  
    public:                 // public attributes/methods  
        Example();          // default constructor  
        Example(int i);     // constructor  
        Example(Example &from); // copy constructor  
        ~Example();        // destructor  
        int meth();         // method  
        int attr2;          // attribute  
        static int sattr;   // class attribute  
};
```



Classes and objects ...

➔ Definition of class attributes and methods (*.cpp file):

```
int Example::sattr = 123; // class attribute
```

```
Example::Example(int i) { // constructor
```

```
    this->attr1 = i;
```

```
}
```

```
int Example::meth() { // method
```

```
    return attr1;
```

```
}
```

➔ specification of class name with attributes and methods

➔ separator :: instead of .

➔ this is a pointer (👉 **5.1.3**), thus this->attr1

➔ alternatively, method bodies can also be specified in the class definition itself



Classes and objects ...

➔ Declaration of objects:

```
{  
    Example ex1;           // initialisation using default constructor  
    Example ex2(10);      // constructor with argument  
    ...  
} // now the destructor for ex1, ex2 is called
```

➔ Access to attributes, invocation of methods

```
ex1.attr2 = ex2.meth();  
j = Example::sattr;      // class attribute
```

➔ Assignment / copying of objects

```
ex1 = ex2;               // object is copied!  
Example ex3(ex2);       // initialisation using copy constructor
```

5.1.3 Pointers (*Zeiger*)



Variables in memory

➔ Reminder: variables are stored in main mamory

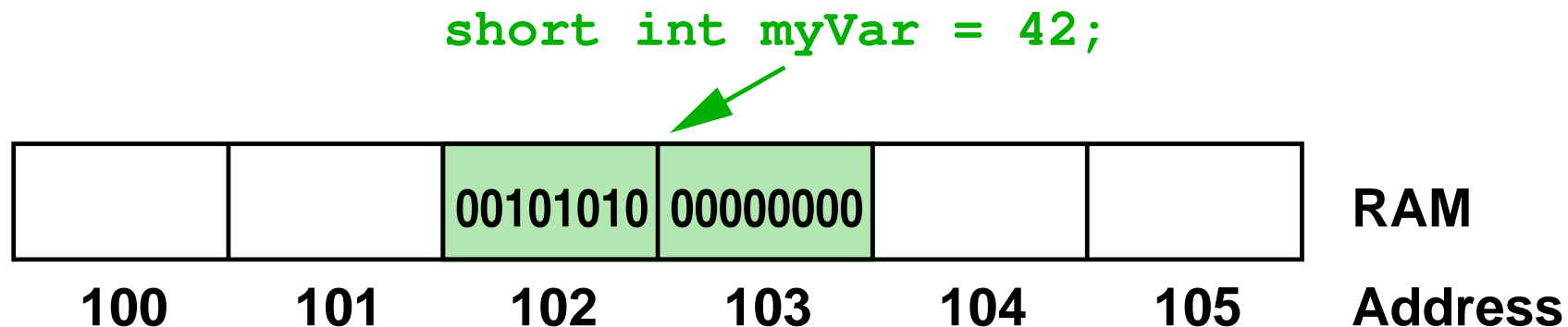

➔ a variable gives a name and a type to a memory block

➔ here: `myVar` occupies 2 bytes (`short int`) starting with address 102

➔ A **pointer** is a memory address, together with a type

➔ the type specifies, how the memory block is interpreted

Declaration and use of pointers

➔ Example:

```
int myAge = 25;    // an int variable
int *pAge;        // a pointer to int values
pAge = &myAge;     // pAge now points to myAge
*pAge = 37;        // myAge now has the value 37
```

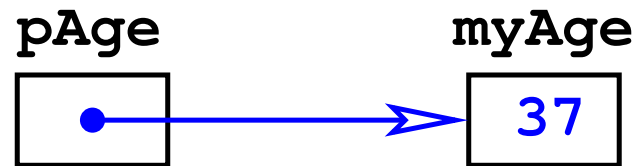

- ➔ The **address operator** & determines the address of a variable
- ➔ The access to *pAge is called **dereferencing** pAge
- ➔ Pointers (nearly) always have a type
 - ➔ e.g. int *, Example *, char **, ...



Passing parameters *by reference*

- ➔ Pointers allow to pass parameters *by reference*
- ➔ Instead of a value, a **pointer** to the values is passed:

```
void byReference(Example *e, int *result) {  
    *result = e->attr2;  
}  
int main() {  
    Example obj(15);           // obj is more efficiently  
    int res;                   // passed by reference  
    byReference(&obj, &res);   // res is a result parameter  
    ...  
}
```

- ➔ short notation: `e->attr2` means `(*e).attr2`



void pointers and type conversion

- ➔ C++ also allows the use of generic pointers
 - ➔ just a memory address without type information
 - ➔ declared type is `void *` (pointer to `void`)
- ➔ Dereferencing only possible after a type conversion
 - ➔ caution: no type safety / type check!
- ➔ Often used for generic parameters of functions:

```
void bsp(int type, void *arg) {  
    if (type == 1) {  
        double d = *(double *)arg; // arg must first be converted  
                                   // to double *  
    } else {  
        int i = *(int *)arg; // int argument  
    }  
}
```



Arrays and pointers

- ➔ C++ does not distinguish between one-dimensional arrays and pointers (with the exception of the declaration)
- ➔ Consequences:
 - ➔ array variables can be used like (constant) pointers
 - ➔ pointer variables can be indexed

```
int a[3] = { 1, 2, 3 };  
int b = *a;           // equivalent to: b = a[0]  
int c = *(a+1);      // equivalent to: c = a[1]  
int *p = a;          // equivalent to: int *p = &a[0]  
int d = p[2];        // d = a[2]
```



Arrays and pointers ...

➔ Consequences ...:

➔ arrays as parameters are always passed *by reference!*

```
void swap(int a[], int i, int j) {  
    int h = a[i];    // swap a[i] and a[j]  
    a[i] = a[j];  
    a[j] = h;  
}  
  
int main() {  
    int ary[] = { 1, 2, 3, 4 };  
    swap(ary, 1, 3);  
    // now: ary[1] = 4, ary[3] = 2;  
}
```



Dynamic memory allocation

- ➔ Allocation of objects and arrays like in Java

```
Example *p = new Example(10);
```

```
int *a = new int[10]; // a is not initialised!
```

```
int *b = new int[10](); // b is initialised (with 0)
```

- ➔ allocation of multi-dimensional arrays does not work in this way
- ➔ Important: C++ does not have a garbage collection
 - ➔ thus explicit deallocation is necessary:

```
delete p; // single object
```

```
delete[] a; // array
```

- ➔ caution: do not deallocate memory multiple times!



Function pointers

- ➔ Pointers can also point to functions:

```
void myFunct(int arg) { ... }  
void test1() {  
    void (*ptr)(int) = myFunct; // function pointer + init.  
    (*ptr)(10); // function call via pointer
```

- ➔ Thus, functions can, e.g., be passed as parameters to other functions:

```
void callIt(void (*f)(int)) {  
    (*f)(123); // calling the passed function  
}  
void test2() {  
    callIt(myFunct); // function as reference parameter
```

5.1.4 Strings and Output



- ➔ Like Java, C++ has a string class (`string`)
 - ➔ sometimes also the type `char *` is used
- ➔ For console output, the objects `cout` and `cerr` are used
- ➔ Both exist in the name space (packet) `std`
 - ➔ for using them without name prefix:
`using namespace std; // corresponds to 'import std.*;' in Java`
- ➔ Example for an output:
`double x = 3.14;`
`cout << "Pi ist approximately " << x << "\n";`
- ➔ Special formatting functions for the output of numbers, e.g.:
`cout << setw(8) << fixed << setprecision(4) << x << "\n";`
 - ➔ output with a field length of 8 and exactly 4 decimal places



➔ **Global** variables

- ➔ are declared outside any function or method
- ➔ live during the complete program execution
- ➔ are accessible by all functions

➔ Global variables and functions can be used only **after** the declaration

➔ thus, for functions we have **function prototypes**

```
int funcB(int n);           // function prototype
int funcA() {                // function definition
    return funcB(10);
}

int funcB(int n) {           // function definition
    return n * n;
}
```



- ➔ Keyword `static` used with the declaration of global variables or functions

```
static int number;
```

```
static void output(char *str) { ... }
```

- ➔ causes the variable/function to be usable only in the local source file

- ➔ Keyword `const` used with the declaration of variables or parameters

```
const double PI = 3.14159265;
```

```
void print(const char *str) { ... }
```

- ➔ causes the variables to be read-only
- ➔ roughly corresponds to `final` in Java
- ➔ (note: this description is extremely simplified!)



➔ Passing command line arguments:

```
int main(int argc, char **argv) {  
    if (argc > 1)  
        cout << "Argument 1: " << argv[1] << "\n";  
}
```

Example invocation: bslab1% ./myprog -p arg2
Argument 1: -p

- ➔ argc is the number of arguments (incl. program name)
- ➔ argv is an array (of length argc) of strings (char *)
- ➔ in the example: `argv[0] = "./myprog"`
`argv[1] = "-p"`
`argv[2] = "arg2"`
- ➔ important: check the index against argc

Overview

- ➔ There are several (standard) libraries for C/C++, which always come with one or more header files, e.g.:

Header file	Library (g++ option)	Description	contains, e.g.
iostream		input/output	cout, cerr
string		C++ strings	string
stdlib.h		standard funct.	exit()
sys/time.h		time functions	gettimeofday()
math.h	-lm	math functions	sin(), cos(), fabs()
pthread.h	-lpthread	threads	pthread_create()
mpi.h	-lmpich	MPI	MPI_Init()



Functions of the preprocessor:

➔ Embedding of header file

```
#include <stdio.h> // searches only in system directories  
#include "myhdr.h" // also searches in current directory
```

➔ Macro expansion

```
#define BUFSIZE 100 // Constant  
#define VERYBAD i + 1; // Extremely bad style !!  
#define GOOD (BUFSIZE+1) // Parenthesis are important!
```

...

```
int i = BUFSIZE; // becomes int i = 100;  
int a = 2*VERYBAD // becomes int a = 2*i + 1;  
int b = 2*GOOD; // becomes int a = 2*(100+1);
```



Functions of the preprocessor: ...

- ➔ Conditional compilation (e.g., for debugging output)

```
int main() {  
#ifdef DEBUG  
    cout << "Program has started\n";  
#endif  
    ...  
}
```

- ➔ output statement normally will not be compiled

- ➔ to activate it:

- ➔ either `#define DEBUG` at the beginning of the program
- ➔ or compile with `g++ -DDEBUG ...`

Parallel Processing

WS 2017/18

20.11.2017

Roland Wismüller
Universität Siegen
roland.wismueller@uni-siegen.de
Tel.: 0271/740-4050, Büro: H-B 8404

Stand: January 23, 2018

5.2.1 Compilation and Execution

- ➔ Compilation: use gcc (g++)
 - ➔ typical call: `g++ -fopenmp myProg.cpp -o myProg`
 - ➔ OpenMP 3.0 since gcc 4.4, OpenMP 4.0 since gcc 4.9
- ➔ Execution: identical to a sequential program
 - ➔ e.g.: `./myProg`
 - ➔ (maximum) number of threads can be specified in environment variable `OMP_NUM_THREADS`
 - ➔ e.g.: `export OMP_NUM_THREADS=4`
 - ➔ specification holds for all programs started in the same shell
 - ➔ also possible: temporary (re-)definition of `OMP_NUM_THREADS`
 - ➔ e.g.: `OMP_NUM_THREADS=2 ./myProg`

- ➔ There are only few debuggers that fully support OpenMP
 - ➔ e.g., Totalview
 - ➔ requires tight cooperation between compiler and debugger
- ➔ On the PCs in the lab room H-A 4111:
 - ➔ gdb and ddd allow halfway reasonable debugging
 - ➔ they support multiple threads
 - ➔ gdb: textual debugger (standard LINUX debugger)
 - ➔ ddd: graphical front end for gdb
 - ➔ more comfortable, but more “heavy-weight”
- ➔ On the HorUS cluster: `totalview`
 - ➔ graphical debugger
 - ➔ supports both OpenMP and MPI



- ➔ Prerequisite: compilation with debugging information
 - ➔ sequential: `g++ -g -o myProg myProg.cpp`
 - ➔ with OpenMP: `g++ -g -fopenmp ...`
- ➔ Limited(!) debugging is also possible in combination with optimization
 - ➔ however, the debugger may show unexpected behavior
 - ➔ if possible: switch off the optimization
 - ➔ `g++ -g -O0 ...`

Important functions of a debugger (Examples for gdb):

- ➔ Start the programm: `run arg1 arg2`
- ➔ Set breakpoints on code lines: `break file.cpp:35`
- ➔ Set breakpoints on functions: `break myFunc`
- ➔ Show the procedure call stack: `where`
- ➔ Navigate in the procedure call stack: `up` bzw. `down`
- ➔ Show the contents of variables: `print i`
- ➔ Change the contents of variables: `set variable i=i*15`
- ➔ Continue the program (after a breakpoint): `continue`
- ➔ Single-step execution: `step` bzw. `next`

Important functions of a debugger (Examples for `gdb`): ...

- ➔ Show all threads: `info threads`
- ➔ Select a thread: `thread 2`
 - ➔ subsequent commands typically only affect the selected thread
- ➔ Source code listing: `list`
- ➔ Help: `help`
- ➔ Exit the debugger: `quit`

- ➔ All commands can also be abbreviated in `gdb`



Sample session with `gdb` (sequential)

```
bsclk01> g++ -g -O0 -o ross ross.cpp ← Option -g for debugging
bsclk01> gdb ./ross
GNU gdb 6.6
Copyright 2006 Free Software Foundation, Inc.
GDB is free software, covered by the GNU General Public ...
(gdb) b main ← Set breakpoint on function main
Breakpoint 1 at 0x400d00: file ross.cpp, line 289.
(gdb) run 5 5 0 ← Start program with given arguments
Starting program: /home/wismueller/LEHRE/pv/ross 5 5 0
Breakpoint 1, main (argc=4, argv=0x7fff0a131488) at ross.cpp:289
289     if (argc != 4) {
(gdb) list ← Listing around the current line
284
285     /*
286     ** Get and check the command line arguments
```

5.2.2 Debugging ...



```
287     */
288
289     if (argc != 4) {
290         cerr << "Usage: ross <size_x> <size_y> ...
291             <size_x> <size_y>: size...
292             <all>: 0 = compute one ...
293             1 = compute all ...
```

(gdb) **b 315** ← Set breakpoint on line 315

Breakpoint 2 at 0x400e59: file ross.cpp, line 315.

(gdb) **c** ← Continue the program

Continuing.

Breakpoint 2, main (argc=4, argv=0x7fff0a131488) at ross.cpp:315

```
315         num_moves = Find_Route(size_x, size_y, moves);
```

(gdb) **n** ← Execute next source line (here: 315)

```
320         if (num_moves >= 0) {
```

(gdb) **p num_moves** ← Print contents of num_moves

```
$1 = 24
```

5.2.2 Debugging ...



(gdb) **where** ← Where is the program currently stopped?

```
#0 main (argc=4, argv=0x7fff0a131488) at ross.cpp:320
```

(gdb) **c** ← Continue program

Continuing.

Solution:

...

Program exited normally.

(gdb) **q** ← exit gdb

```
bsclk01>
```



Sample session with gdb (OpenMP)

```
bslab03> g++ -fopenmp -O0 -g -o heat heat.cpp solver-jacobi.cpp
bslab03> gdb ./heat
GNU gdb (GDB) SUSE (7.5.1-2.1.1)
...
(gdb) run 500
...
Program received signal SIGFPE, Arithmetic exception.
0x0000000000401711 in solver._omp_fn.0 () at solver-jacobi.cpp:58
58                                     b[i][j] = i/(i-100);
(gdb) info threads
  Id      Target Id      Frame
  4       Thread ... (LWP 6429) ... in ... at solver-jacobi.cpp:59
  3       Thread ... (LWP 6428) ... in ... at solver-jacobi.cpp:59
  2       Thread ... (LWP 6427) ... in ... at solver-jacobi.cpp:63
* 1      Thread ... (LWP 6423) ... in ... at solver-jacobi.cpp:58
(gdb) q
```

5.2.2 Debugging ...



Sample session with ddd

Breakpoint

Current position

```
*/
num_moves = Find_Route(size_x, size_y, moves);

/*
** Print the result.
*/
if (num_moves >= 0) {
    printf("Solution:\n\n");
}
```

Listing
(commands via right mouse button)

Menu

Copyright © 2001–2004 Free Software Foundation, Inc.
Using host libthread_db library "/lib/tls/libthread_db.so.1".
(gdb) break ross.c:315
Breakpoint 1 at 0x8048b80: file ross.c, line 315.
(gdb) run 5 5 0

Breakpoint 1, main (argc=4, argv=0xbf8df1b4) at ross.c:315
(gdb) next
(gdb) print num_moves
\$1 = 24
(gdb) I

Input/Output
(also input of gdb commands)

5.2.2 Debugging ...



Sample session with totalview

The screenshot shows the TotalView debugger interface. A red circle highlights the 'Group (Control)' toolbar with buttons for Go, Halt, Kill, Restart, Next Step, Out, Run To, Record, GoBack, Prev, UnStep, Caller, BackTo, and Live. A red arrow points to the 'Go' button, labeled 'Commands'. Below the toolbar, the 'Stack Trace' and 'Stack Frame' panels are visible. The 'Stack Trace' panel shows a call stack with 'solver._omp_fn.0' at the top. The 'Stack Frame' panel shows the current function's context, including 'Block "\$b1#\$b1"', 'i: 0x00000064 (100)', 'Block "\$b1": 1 Variables', and local variables 'a', 'n', 'diff', and 'b'. A red arrow points to the '1 Variables' text, labeled 'Variables'. Below the stack panels is the 'Listing' panel, showing the source code of 'Function solver._omp_fn.0 in solver-jacobi.c'. The code is stopped at line 55, marked with a red 'STOP' box. A red arrow points to this box, labeled 'Breakpoint'. The current position is at line 58, indicated by a yellow highlight and a red arrow, labeled 'Current position'. The listing shows a nested loop: 'for (i=1; i<n-1; i++) { for (j=1; j<n-1; j++) { b[i][j] = 0.25 * (a[i][j-1] + a[i-1][j] + a[i-1][j-1] + a[i][j+1] + a[i+1][j] + a[i+1][j-1] + a[i][j-1] + a[i][j+1]); b[i][j] = 1/(i-100); /* Bestimme maximale Änderung der Matrix... */ } }'. A red arrow points to the listing area, labeled 'Listing (commands via right mouse button)'. At the bottom, the 'Threads' panel shows a table of threads. A red arrow points to the 'Threads' panel, labeled 'Threads'.

Action Points	Processes	Threads	
1.1	(46912510897024)	T	in solver._omp_fn.0
1.2	(46912517011200)	T	in solver._omp_fn.0
1.3	(46912519112448)	E	in solver._omp_fn.0
1.4	(46912521213696)	T	in solver._omp_fn.0
1.5	(46912523314944)	T	in solver._omp_fn.0



5.2.3 Performance Analysis

- ➔ Typically: **instrumentation** of the generated executable code during/after the compilation
 - ➔ insertion of code at important places in the program
 - ➔ in order monitor relevant events
 - ➔ e.g., at the beginning/end of parallel regions, barriers, ...
 - ➔ during the execution, the events will be
 - ➔ individually logged in a **trace file** (*Spurdatei*)
 - ➔ or already summarized into a **profile**
 - ➔ Evaluation is done after the program terminates
 - ➔ c.f. Section 1.9.6
- ➔ In the H-A 4111: Scalasca



Performance analysis using Scalasca

- ➔ Set the paths (in H-A 4111; HorUS: see 5.2.4)
 - ➔ `export PATH=/opt/dist/scorep-1.4.1/bin:\`
`/opt/dist/scalasca-2.2.1/bin:$PATH`
- ➔ Compile the program:
 - ➔ `scalasca -instrument g++ -fopenmp ... barrier.cpp`
- ➔ Execute the program:
 - ➔ `scalasca -analyze ./barrier`
 - ➔ stores data in a directory `scorep_barrier_0x0_sum`
 - ➔ `0x0` indicates the number of threads (0 = default)
 - ➔ directory must not yet exist; remove it, if necessary
- ➔ Interactive analysis of the recorded data:
 - ➔ `scalasca -examine scorep_barrier_0x0_sum`

5.2.3 Performance Analysis ...



Performance analysis using Scalasca: Example from slide 215

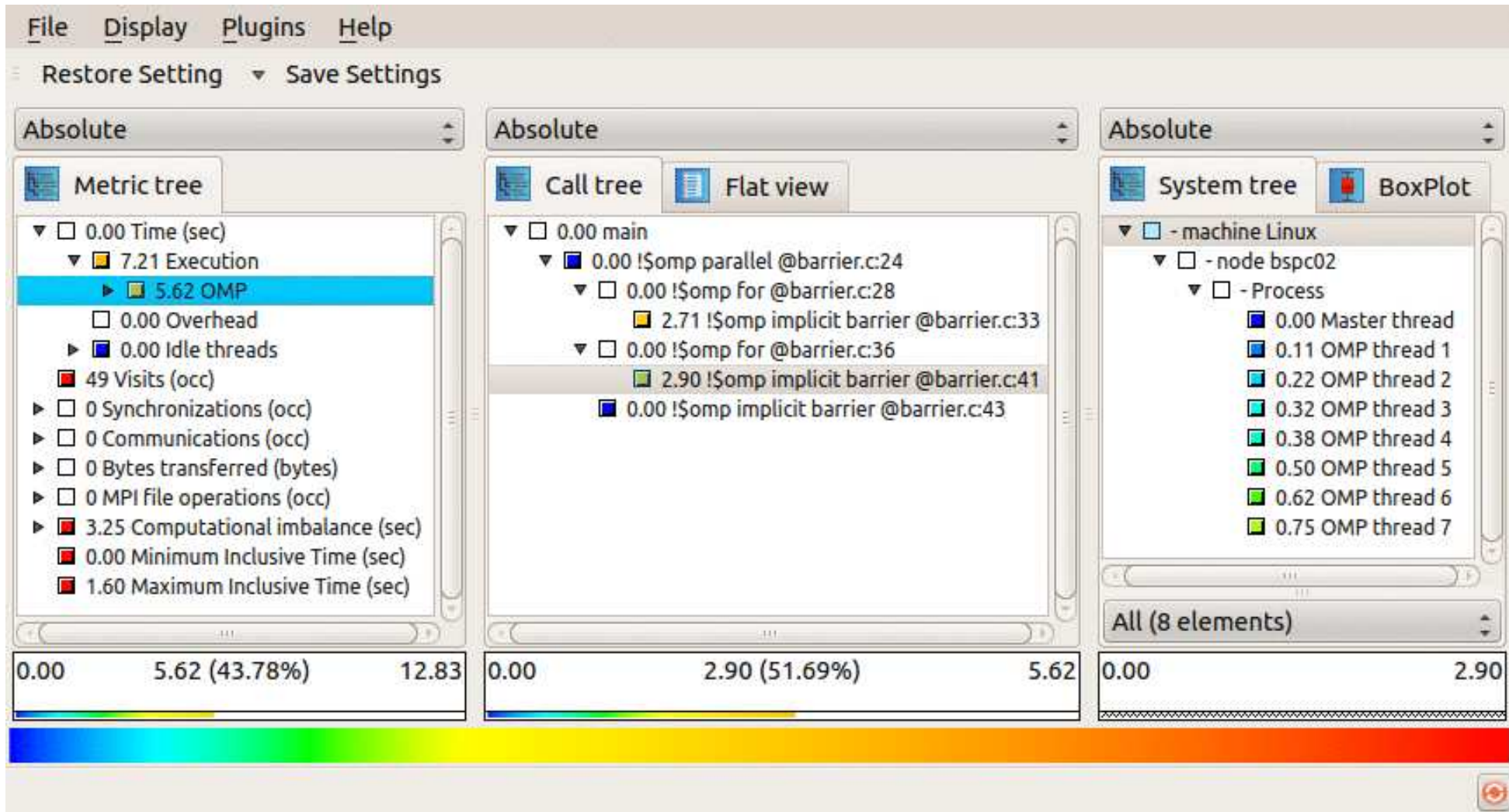

5.2.3 Performance Analysis ...



Performance analysis using Scalasca: Example from slide 215 ...

- ➔ In the example, the waiting time at barriers in the first loop can be reduced drastically by using the option `nowait`:

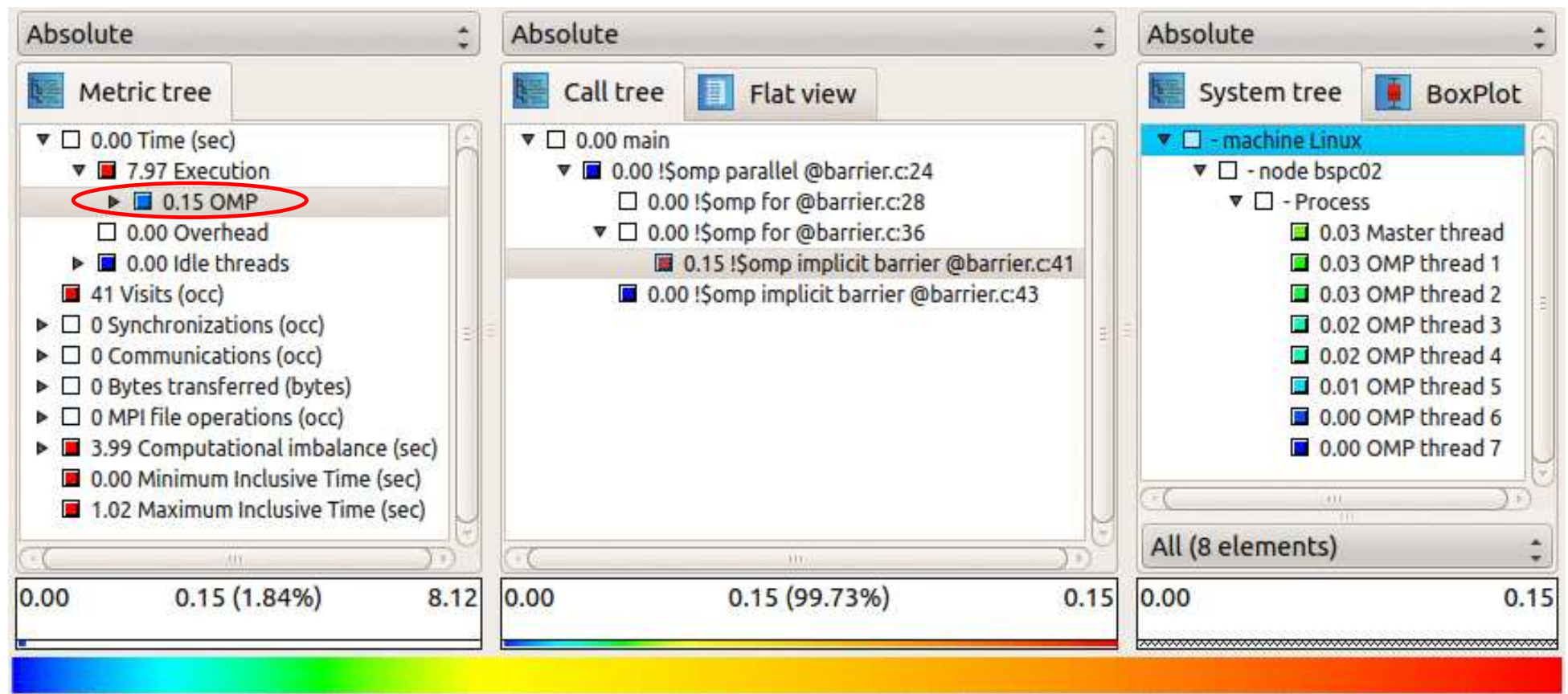



Architecture of the HorUS cluster

- ➔ 34 Dell PowerEdge C6100 systems, each with 4 nodes
- ➔ 136 compute nodes
 - ➔ CPU: 2 x Intel Xeon X5650, 2.66 GHz, 6 cores per CPU, 12 MB cache
 - ➔ main memory: 48 GB (4GB per core, 1333 MHz DRR3)
 - ➔ hard disk: 500 GB SATA (7,2k RPM, 3,5 Zoll)
- ➔ In total: 272 CPUs, 1632 cores, 6,4 TB RAM, 40 TB disk
- ➔ Parallel file system: 33 TB, 2.5 GB/s
- ➔ Infiniband network (40 GBit/s)
- ➔ Peak performance: 17 TFlop/s

Access

➔ Via SSH: `ssh -X g-account@slc.zimt.uni-siegen.de`

➔ In the lab room H-A 4111:

➔ forwarding of SSH connections by the lab gateway

➔ `ssh -X -p 22222 g-account@bslabgate1.lab.bvs`

➔ ideally, use the file `$HOME/.ssh/config`:

➔ Host horus

```
user g-account
```

```
hostname bslabgate1.lab.bvs
```

```
ForwardX11 yes
```

```
HostKeyAlias horus
```

```
port 22222
```

➔ then simply: `ssh horus`



Set-up the SSH in H-A 4111

- ➔ Create an SSH key:
 - ➔ `ssh-keygen -b 2048 -t rsa` (oder `-b 4096`)
 - ➔ when asked "Enter file ..." just press Return
 - ➔ choose a secure passphrase for your private key!
- ➔ Append the public key to the list of authorized keys:
 - ➔ `cat ~/.ssh/id_rsa.pub >> ~/.ssh/authorized_keys`
- ➔ With that, you can also log into other lab computers without permanently having to type the password



Set-up the environment on HorUS

- ➔ Copy your (public!) SSH key to HorUS
 - ➔ `ssh-copy-id -i ~/.ssh/id_rsa.pub horus`
 - ➔ **Important:** take care that you type your password correctly!

- ➔ Define the modules you need on the HorUS cluster:

```
module load default-environment
module load PrgEnv/gcc-openmpi/5.1.0-1.8.1
module load gcc/5.1.0
module load scalasca/gcc-openmpi_5.1.0-1.8.1/2.3.1
module load scorep/gcc-openmpi_5.1.0-1.8.1/2.0.2
export PATH=$PATH:/cm/shared/ZIMT/apps/cube/4.3.4/gcc/bin
```

for Scalasca

- ➔ the best is to append these commands to `~/.profile`



Using the HorUS cluster in practice

- ➔ Mount the file system of HorUS onto your lab computer
 - ➔ create a directory for the mount point: `mkdir ~/mnt`
 - ➔ mount the HorUS file system: `sshfs horus: ~/mnt`
 - ➔ unmount: `fusermount -u ~/mnt`
- ➔ Starting programs on HorUS
 - ➔ HorUS uses the batch queueing system SLURM
 - ➔ see <https://computing.llnl.gov/linux/slurm>
 - ➔ starting an OpenMP program, e.g.:
 - ➔ `export OMP_NUM_THREADS=8`
 - ➔ `salloc --exclusive --partition short \`
`$HOME/GAUSS/heat 500`

Parallel Processing

WS 2017/18

04.12.2017

Roland Wismüller
Universität Siegen
roland.wismueller@uni-siegen.de
Tel.: 0271/740-4050, Büro: H-B 8404

Stand: January 23, 2018

Background

- ➔ Sokoban: japanese for “warehouse keeper”
- ➔ Computer game, developed in 1982 by Hiroyuki Imabayashi
- ➔ Goal: player must push all objects (boxes) to the target positions (storage locations)
 - ➔ boxes can only be pushed, not pulled
 - ➔ only one box can be pushed at a time

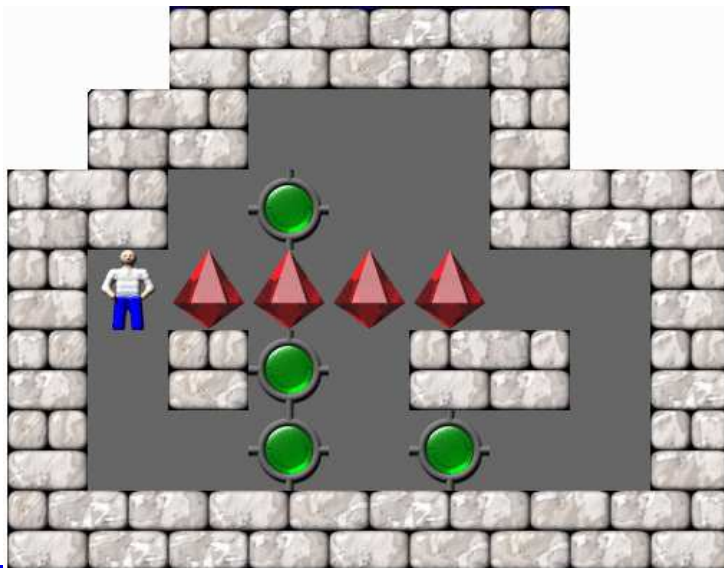

Background

- ➔ Sokoban: japanese for “warehouse keeper”
- ➔ Computer game, developed in 1982 by Hiroyuki Imabayashi
- ➔ Goal: player must push all objects (boxes) to the target positions (storage locations)
 - ➔ boxes can only be pushed, not pulled
 - ➔ only one box can be pushed at a time

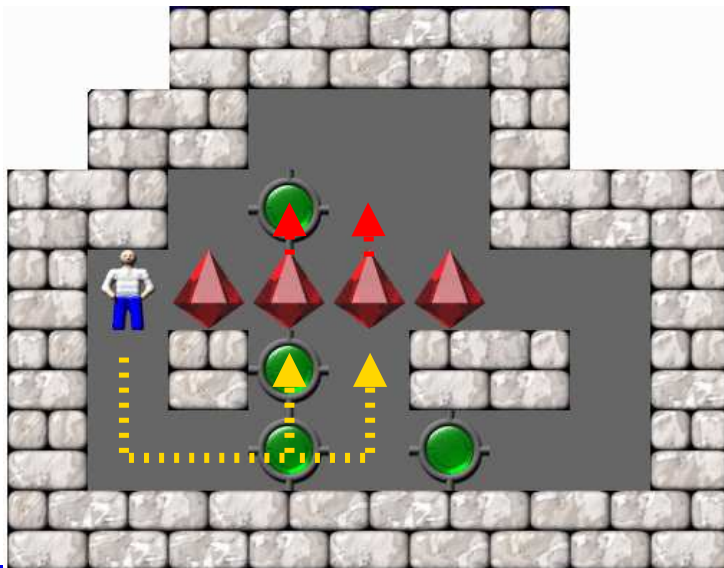

Background

- ➔ Sokoban: japanese for “warehouse keeper”
- ➔ Computer game, developed in 1982 by Hiroyuki Imabayashi
- ➔ Goal: player must push all objects (boxes) to the target positions (storage locations)
 - ➔ boxes can only be pushed, not pulled
 - ➔ only one box can be pushed at a time

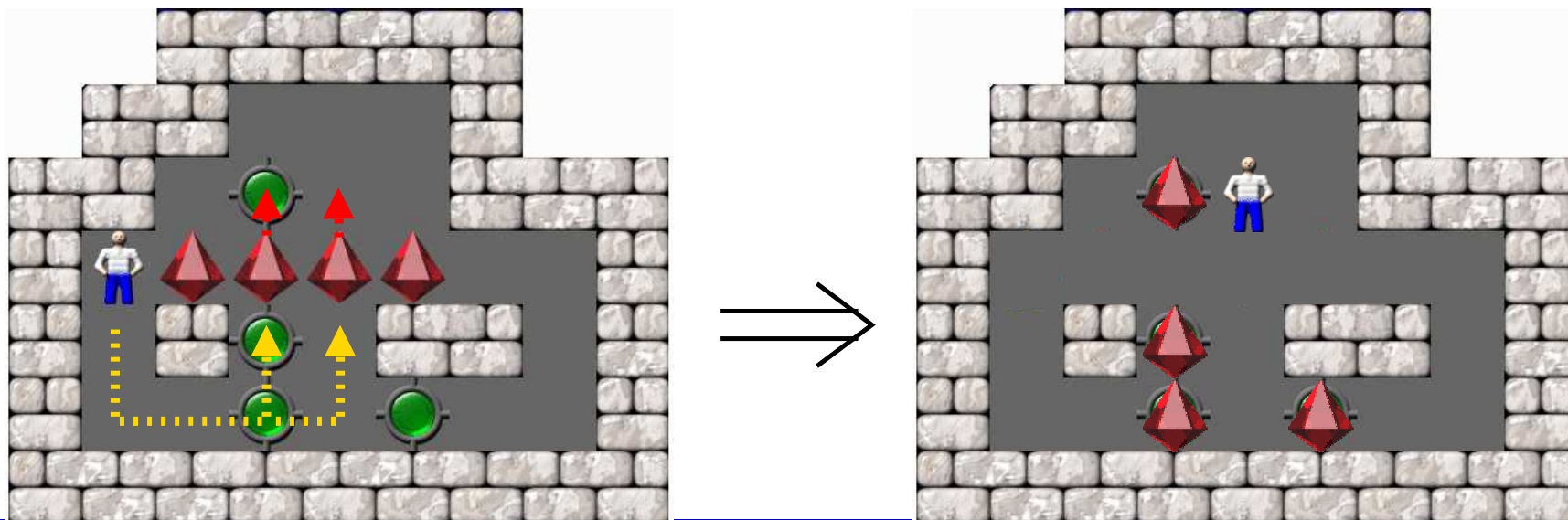

How to find the sequence of moves?

- ➔ Configuration: state of the play field
 - ➔ positions of the boxes
 - ➔ position of the player (connected component)
- ➔ Each configuration has a set of successor configurations
- ➔ Configurations with successor relation build a directed graph
 - ➔ not a tree, since cycles are possible!
- ➔ Wanted: shortest path from the root of the graph to the goal configuration
 - ➔ i.e., smallest number of box moves

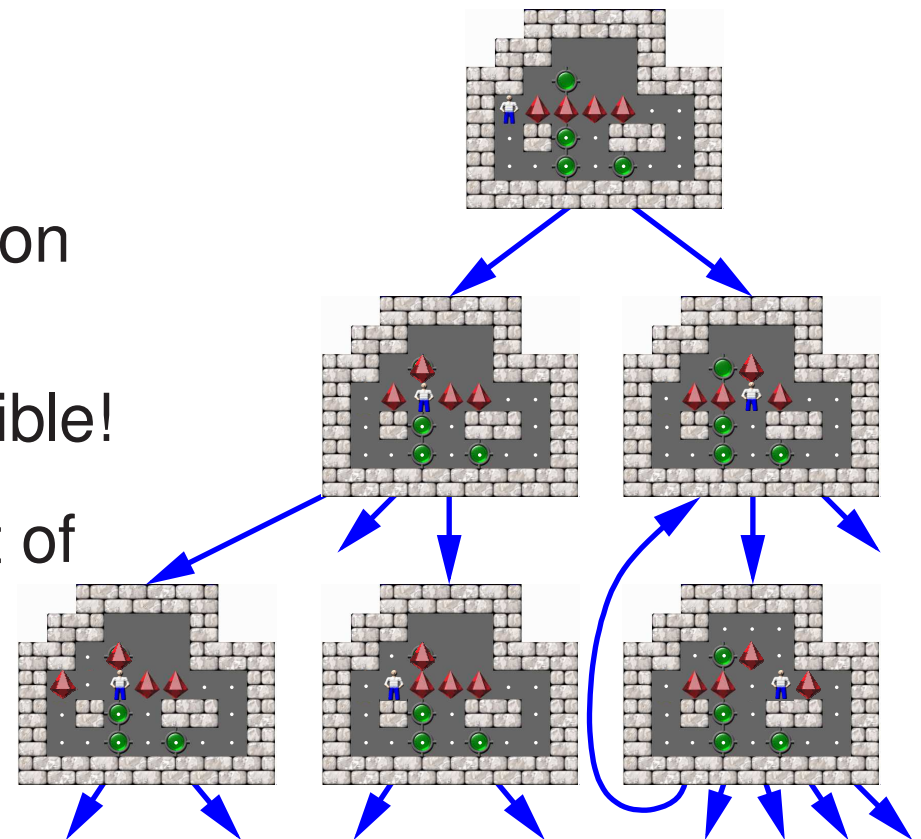

5.3 Exercise: Sokoban Solver ...



How to find the sequence of moves?

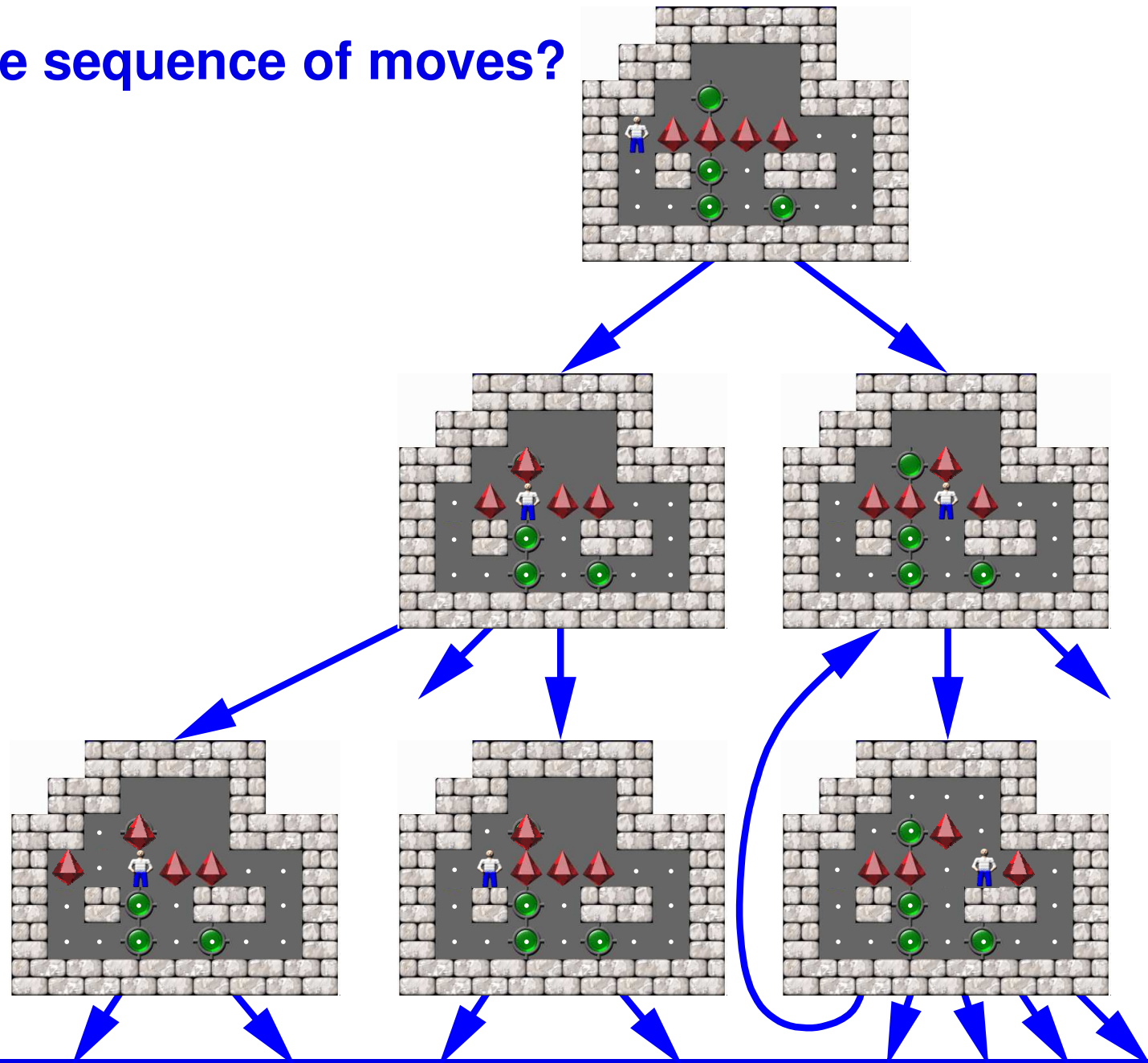

How to find the sequence of moves? ...

➔ Two alternatives:

➔ depth first search

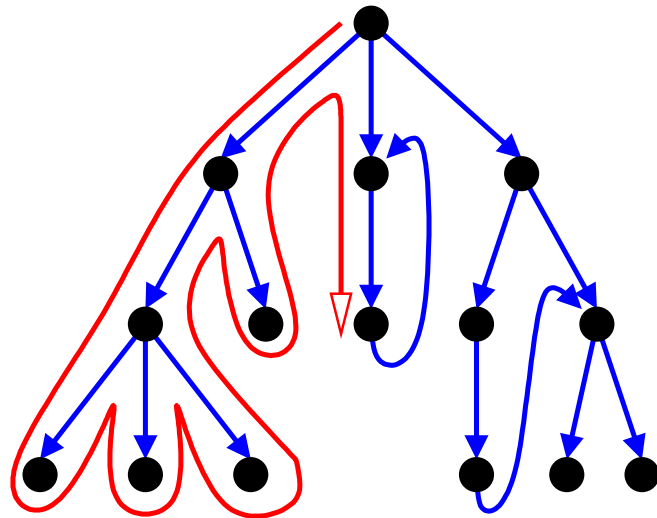

➔ problems:

➔ cycles

➔ handling paths with different lengths

➔ breadth first search

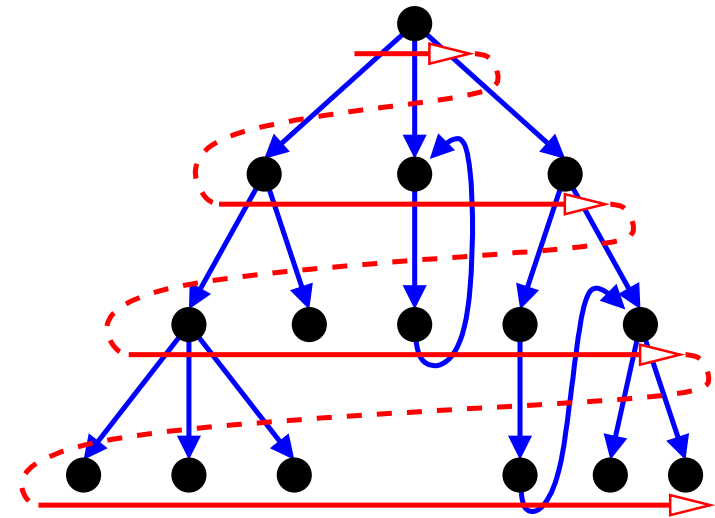

➔ problems:

➔ reconstruction of the path to a node

➔ memory requirements



Backtracking algorithm for depth first search:

```
DepthFirstSearch(conf): // conf = current configuration
  append conf to the solution path
  if conf is a solution configuration:
    found the solution path
    return
  if depth is larger than the depth of the best solution so far:
    remove the last element from the solution path
    return // cancel the search in this branch
  for all possible successor configurations c of conf:
    if c has not yet been visited at a smaller or equal depth:
      remember the new depth of c
      DepthFirstSearch(c) // recursion
  remove the last element from the solution path
  return // backtrack
```





Algorithm for breadth first search:

```
BreadthFirstSearch(conf): // conf = start configuration
  add conf to the queue at depth 0
  depth = 1;
  while the queue at depth depth-1 is not empty:
    for all configurations conf in this queue:
      for all possible successor configurations c of conf:
        if configuration c has not been visited yet:
          add the configuration c with predecessor conf to the
            set of visited configurations and to the queue for
            depth depth
          if c is a solution configuration:
            determine the solution path to c
            return // found a solution
        depth = depth+1
  return // no solution
```

Example for the *backtracking* algorithm

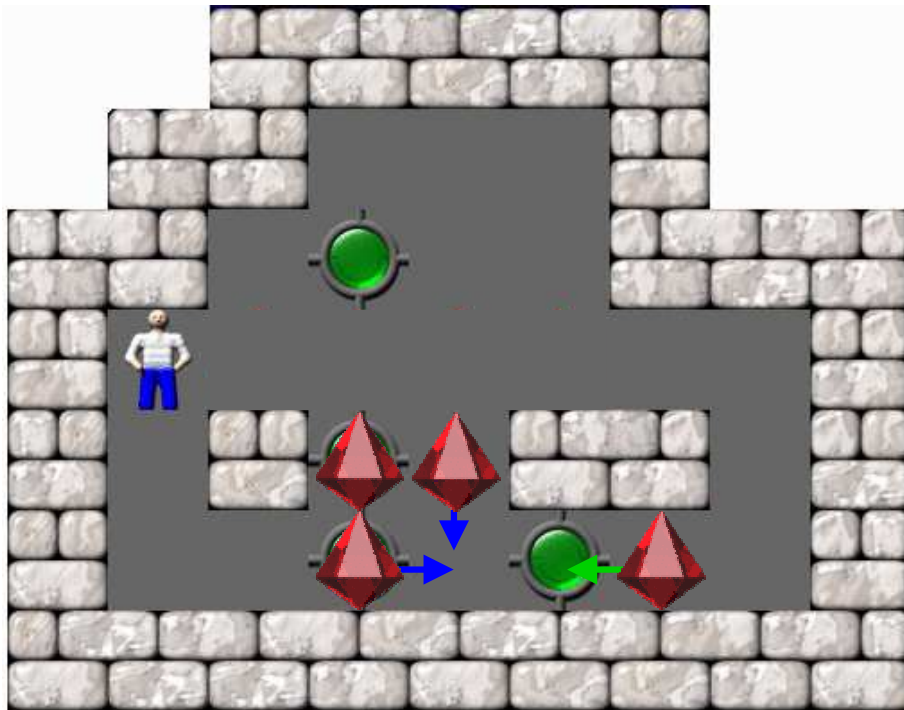
Configuration with possible moves



- ← Possible move
- ← Chosen move

Example for the *backtracking* algorithm

Move has been executed

New configuration with possible moves

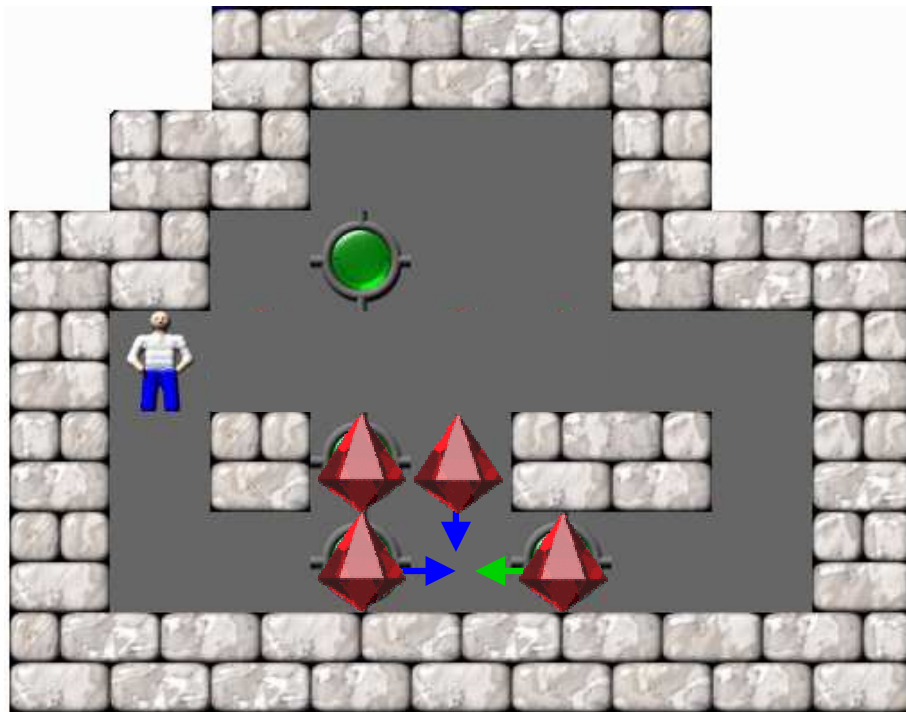

- ← Possible move
- ← Chosen move

Example for the *backtracking* algorithm

Move has been executed
No further move is possible

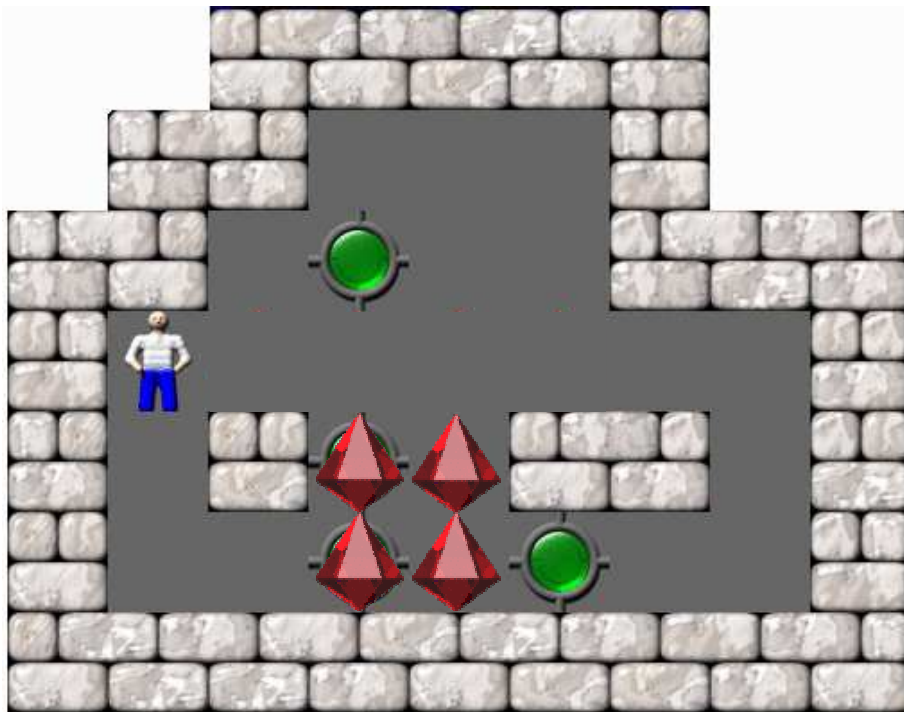

← Possible move
← Chosen move

Example for the *backtracking* algorithm

Backtrack

Back to previous configuration, next move

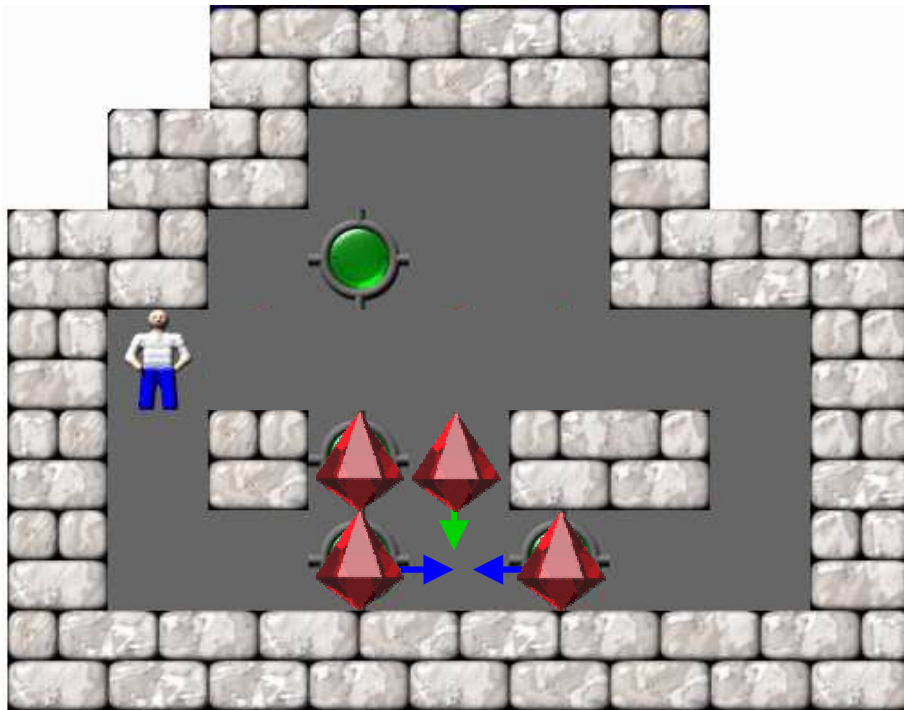

- ← Possible move
- ← Chosen move

Parallel Processing

WS 2017/18

15.01.2018

Roland Wismüller
Universität Siegen
roland.wismueller@uni-siegen.de
Tel.: 0271/740-4050, Büro: H-B 8404

Stand: January 23, 2018



5.4.1 Compile and Run

Available MPI implementations

- ➔ MPICH2 1.2.1 (in H-A 4111), OpenMPI 1.8.1 (HorUS)
- ➔ Portable implementations of the MPI-2 standard
- ➔ MPICH2 also provides the visualization tool `jumpshot`

Compiling MPI programs: `mpic++`

- ➔ `mpic++ -o myProg myProg.cpp`
- ➔ Not a separate compiler for MPI, but just a script that defines additional compiler options:
 - ➔ include und linker paths, MPI libraries, ...
 - ➔ option `-show` shows the invocations of the compiler



Running MPI programs: `mpiexec`

➔ `mpiexec -n 3 myProg arg1 arg2`

➔ starts `myProg arg1 arg2` with 3 processes

➔ `myProg` must be on the command search path or must be specified with (absolute or relative) path name

➔ On which nodes do the processes start?

➔ depends on the implementation and the platform

➔ in MPICH2 (with Hydra process manager): specification is possible via a configuration file:

```
mpiexec -n 3 -machinefile machines myProg arg1 arg2
```

➔ configuration file contains a list of node names, e.g.:

```
bslab01      ← start one process on bslab03
```

```
bslab05:2   ← start two processes on bslab05
```



Using MPICH2 in the lab H-A 4111

- ➔ If necessary, set the path (in `~/ .bashrc`):
 - ➔ `export PATH=/opt/dist/mpich2-1.2.1/bin:$PATH`
- ➔ Remarks on `mpiexec`:
 - ➔ on the other nodes, the MPI programs start in the same directory, in which `mpiexec` was invoked
 - ➔ `mpiexec` uses `ssh` to start an auxiliary process on each node that is listed in the configuration file
 - ➔ even when less MPI processes should be started
 - ➔ avoid an entry `localhost` in the configuration file
 - ➔ it results in problems with `ssh`
 - ➔ sporadically, programs with relative path name (`./myProg`) will not be found; in these cases, specify `$PWD/myProg`



5.4.2 Debugging

- ➔ MPICH2 and OpenMPI support `gdb` and `totalview`
 - ➔ however, in MPICH2 only with the MPD process manager
- ➔ “Hack” in H-A 4111: start a `gdb` / `ddd` for each process
 - ➔ for `gdb`: `mpiexec -enable-x -n ...`
`/opt/dist/mpidebug/mpigdb myProg args`
 - ➔ each `gdb` starts in its own console window
 - ➔ for `ddd`: `mpiexec -enable-x -n ...`
`/opt/dist/mpidebug/mpiddd myProg args`
 - ➔ start the processes using `continue` (not `run ...`)
- ➔ Prerequisite: compilation with debugging information
 - ➔ `mpic++ -g -o myProg myProg.cpp`



5.4.3 Performance Analysis using Scalasca

- ➔ In principle, in the same way as for OpenMP
- ➔ Compiling the program:
 - ➔ `scalasca -instrument mpic++ -o myprog myprog.cpp`
- ➔ Running the programs:
 - ➔ `scalasca -analyze mpiexec -n 4/myprog`
 - ➔ creates a directory `scorep_myprog_4_sum`
 - ➔ `4` indicates the number of processes
 - ➔ directory must not previously exist; delete it, if necessary
- ➔ Interactive analysis of the recorded data:
 - ➔ `scalasca -examine scorep_myprog_4_sum`



5.4.4 Performance Analysis and Visualization using Jumpshot

- ➔ MPICH supports the recording of event traces
 - ➔ Events: call/return of MPI routines, send, receive, ...
- ➔ Enable tracing via an option of `mpic++`
- ➔ `mpic++ -mpe=mpitrace -o myProg myProg.cpp`
 - ➔ prints the events to the console
- ➔ `mpic++ -mpe=mpilog -o myProg myProg.cpp`
 - ➔ stores the events in a trace file `myProg.clog2`
 - ➔ one shared trace file for all processes
 - ➔ analysis of the trace file using `jumpshot`:
 - ➔ format conversion: `clog2T0slog2 myProg.clog2`
 - ➔ visualization: `jumpshot myProg.slog2`



Example: ping-pong programm

➔ Modification in the program: process 0 performs a computation between sending and receiving

➔ just to make the example more interesting ...

➔ Commands:

```
mpic++ -mpe=mpilog -o pingpong pingpong.cpp
```

➔ add the additional code for creating a trace file

```
mpiexec -n 2 -machinefile machines ./pingpong 5 100000
```

➔ creates a trace file pingpong.clog2

```
clog2T0slog2 pingpong.clog2
```

➔ converts pingpong.clog2 to pingpong.slog2

```
jumpshot pingpong.slog2
```

Example: ping-pong programm ...

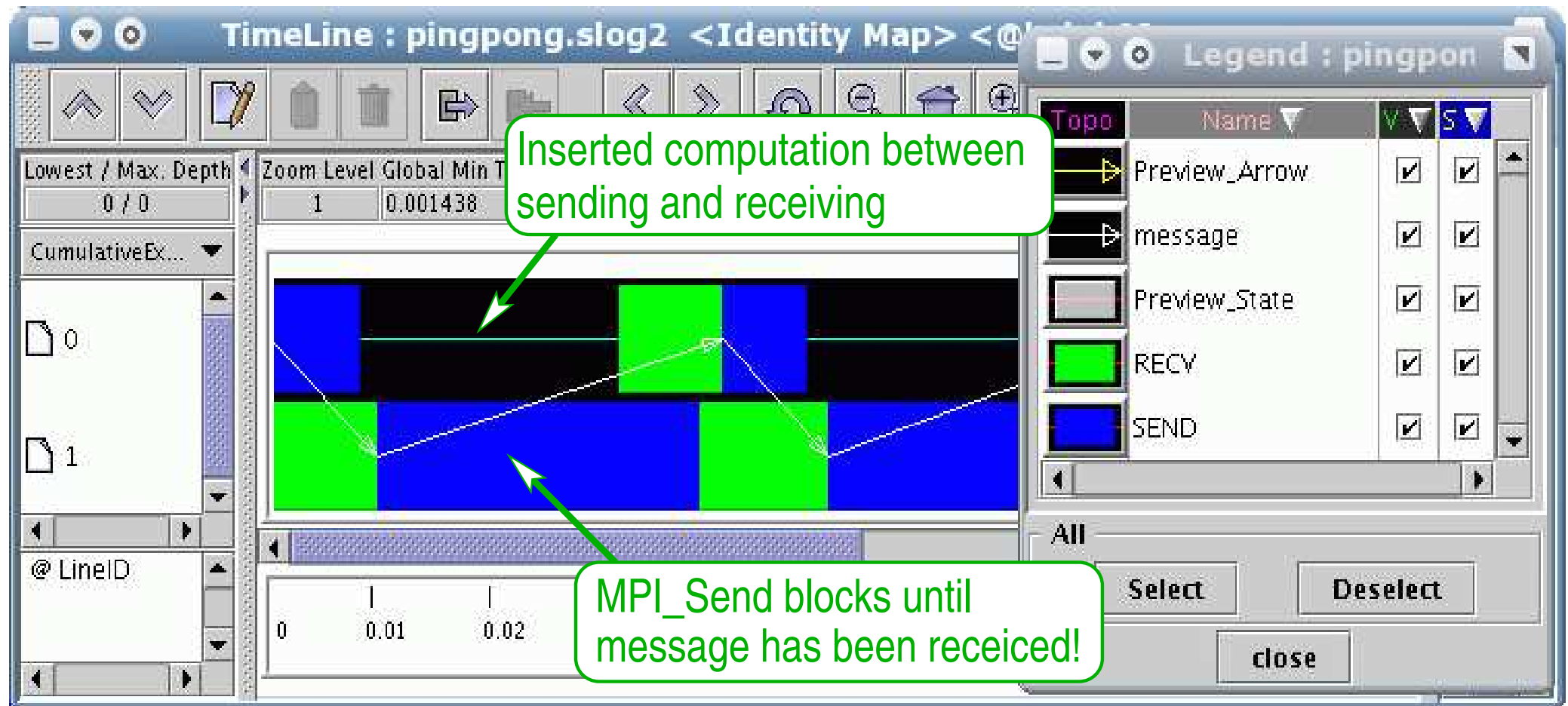



5.4.5 Using the HorUS cluster

➔ Start MPI programs using SLURM, e.g., with:

➔ `salloc --exclusive --partition short --nodes=4 \`
`--ntasks=16 mpiexec $HOME/GAUSS/heat 500`

➔ important options of `salloc`:

➔ `--nodes=4`: number of nodes to be allocated

➔ `--ntasks=16`: total number of processes to be started

➔ For performance analysis: Scalasca

➔ `salloc ... scalasca -analyze mpiexec $HOME/GAUSS...`

➔ For debugging: Totalview

➔ `salloc ... mpiexec -debug $HOME/GAUSS/heat 500`



General approach

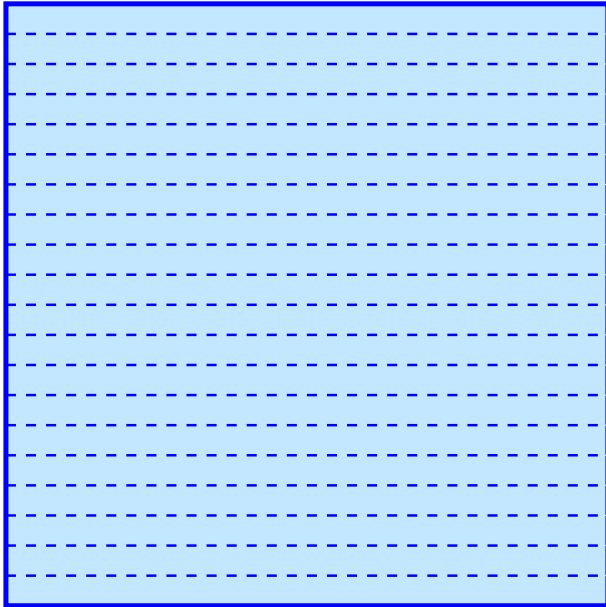

0. Matrix with temperature values



General approach

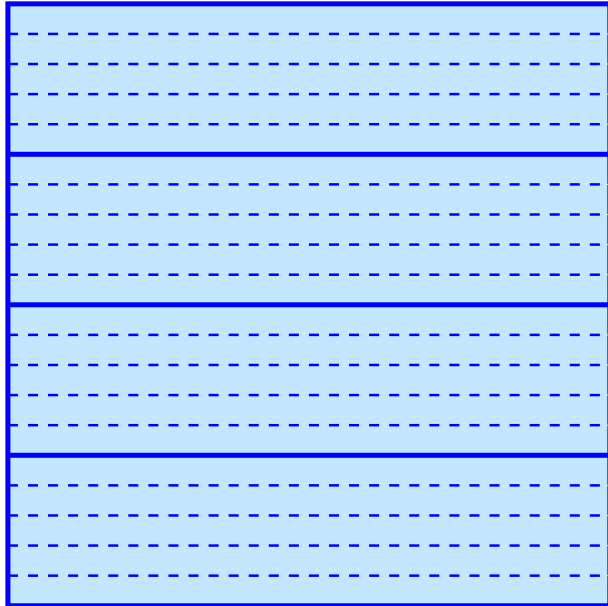

0. Matrix with temperature values
1. Distribute the matrix into stripes



General approach

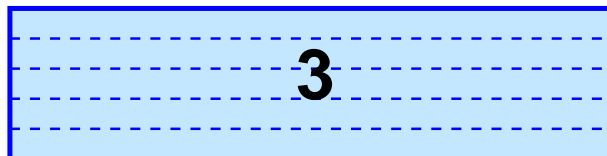
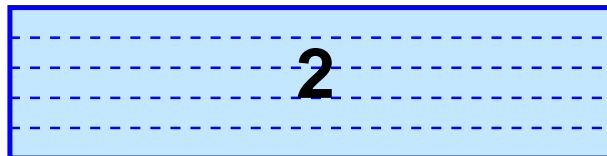
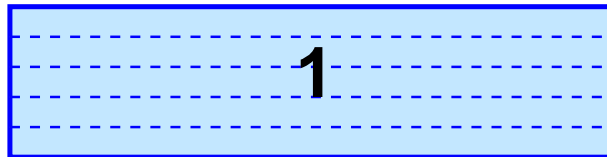
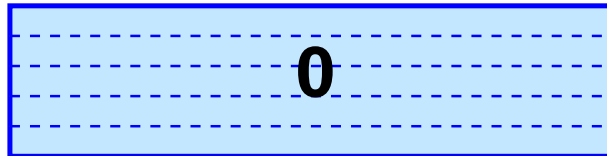

0. Matrix with temperature values

1. Distribute the matrix into stripes

Each process only stores a part of the matrix



General approach

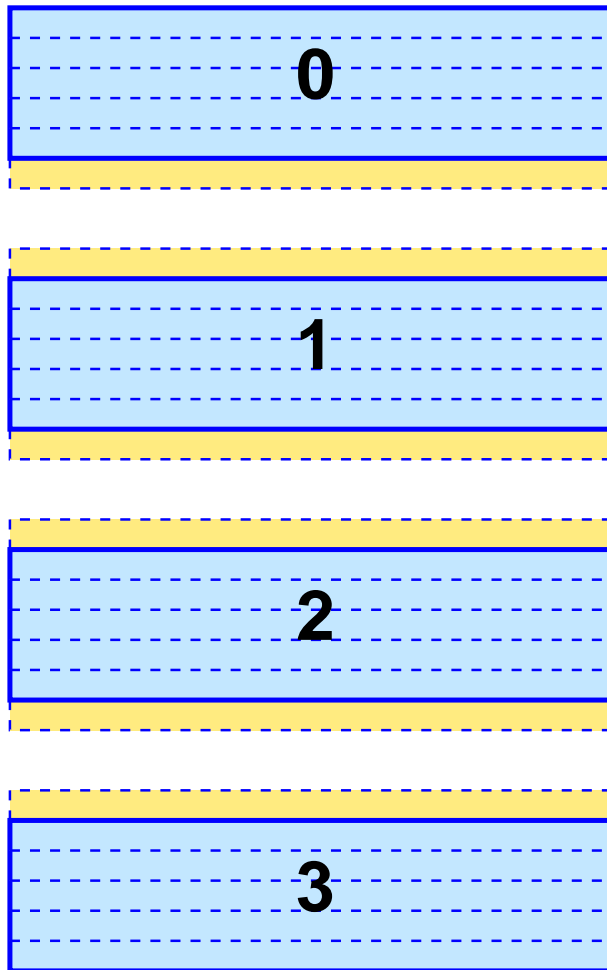

0. Matrix with temperature values

1. Distribute the matrix into stripes

Each process only stores a part of the matrix

2. Introduce ghost zones

Each process stores an additional row at the cutting edges

General approach

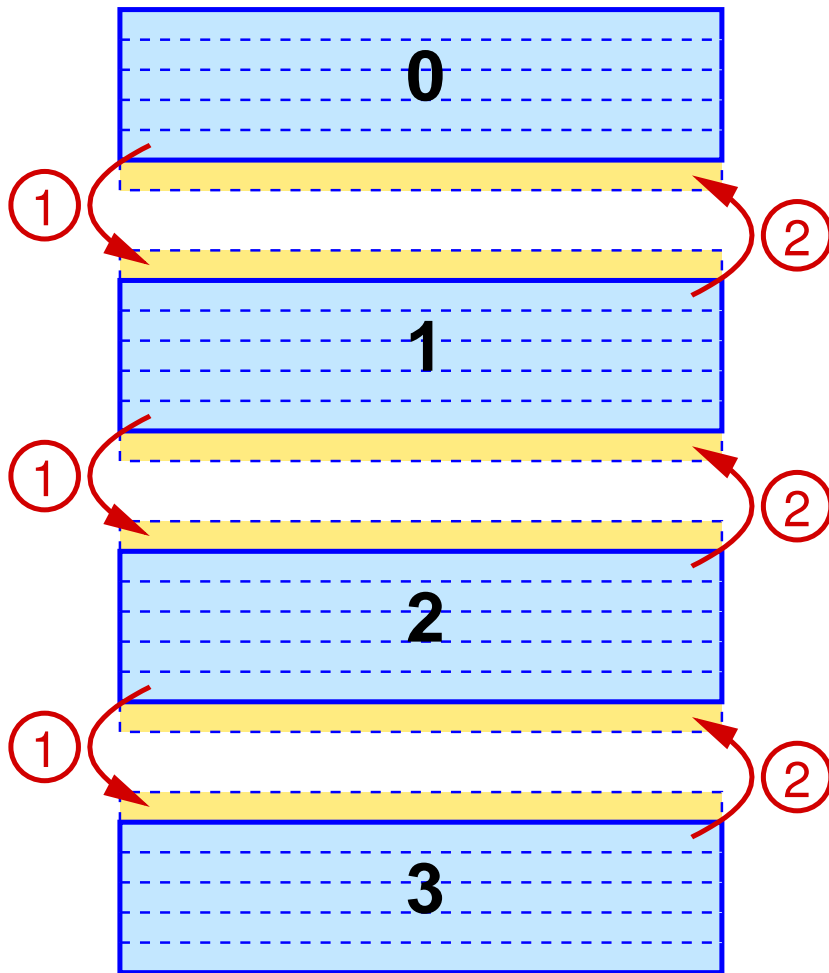

0. Matrix with temperature values

1. Distribute the matrix into stripes

Each process only stores a part of the matrix

2. Introduce ghost zones

Each process stores an additional row at the cutting edges

3. After each iteration the ghost zones are exchanged with the neighbor processes

E.g., first downwards (1),
then upwards (2)



General approach ...

```
int nprocs, myrank;  
double a[LINES][COLS];  
MPI_Status status;
```

```
MPI_Comm_size(MPI_COMM_WORLD, &nprocs);  
MPI_Comm_rank(MPI_COMM_WORLD, &myrank);
```

```
/* Step 1: Send downwards, receive from above */
```

```
if (myrank != nprocs-1)  
    MPI_Send(a[LINES-2], COLS, MPI_DOUBLE, myrank+1, 0,  
            MPI_COMM_WORLD);  
if (myrank != 0)  
    MPI_Recv(a[0], COLS, MPI_DOUBLE, myrank-1, 0,  
            MPI_COMM_WORLD, &status);
```



Distribution of data

- ➔ Close formula for the uniform distribution of an array of length n to np processes:
 - ➔ $\text{start}(p) = n \div np \cdot p + \max(p - (np - n \bmod np), 0)$
 - ➔ $\text{size}(p) = (n + p) \div np$
 - ➔ process p receives $\text{size}(p)$ elements starting at index $\text{start}(p)$
- ➔ This results in the following index transformation:
 - ➔ $\text{tolocal}(i) = (p, i - \text{start}(p))$
mit $p \in [0, np - 1]$ so, daß $0 \leq i - \text{start}(p) < \text{size}(p)$
 - ➔ $\text{toglobal}(p, i) = i + \text{start}(p)$
- ➔ In addition, you have to consider the ghost zones for Jacobi and Gauss/Seidel!



Distribution of computation

- ➔ In general, using the *owner computes* rule
 - ➔ the process that writes a data element also performs the corresponding calculations
- ➔ Two approaches for technically realizing this:
 - ➔ index transformation and conditional execution
 - ➔ e.g., when printing the verification values of the matrix:

```
if ((x-start >= 0) && (x-start < size))
    cout << "a[" << x << "]= " << a[x-start] << "\n";
```
 - ➔ adjustment of the enclosing loops
 - ➔ e.g., during the iteration or when initializing the matrix:

```
for (i=0; i<size; i++)
    a[i] = 0;
```



On the parallelization of the Gauss/Seidel method

➔ Similar to the pipelined parallelization with OpenMP (👉 2.5)

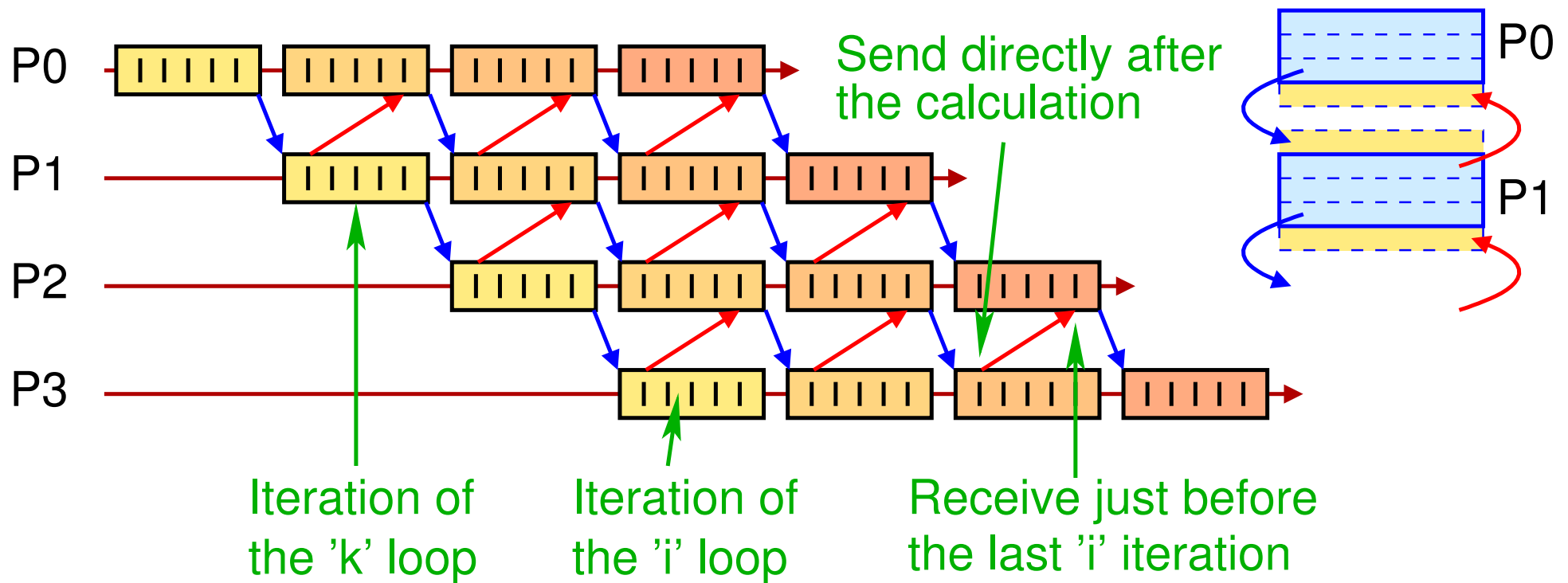



Obtained speedup for different matrix sizes

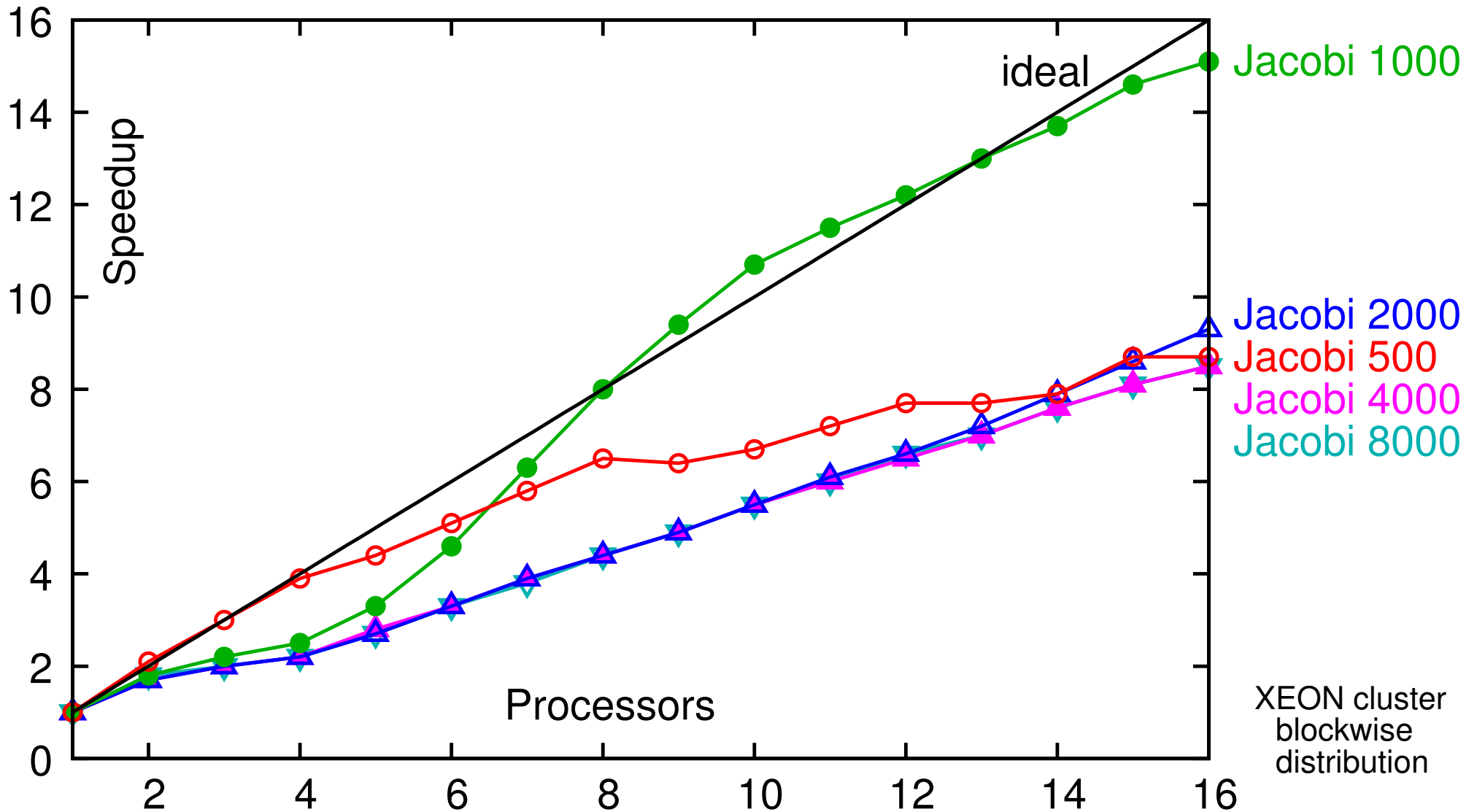



Obtained speedup for different matrix sizes

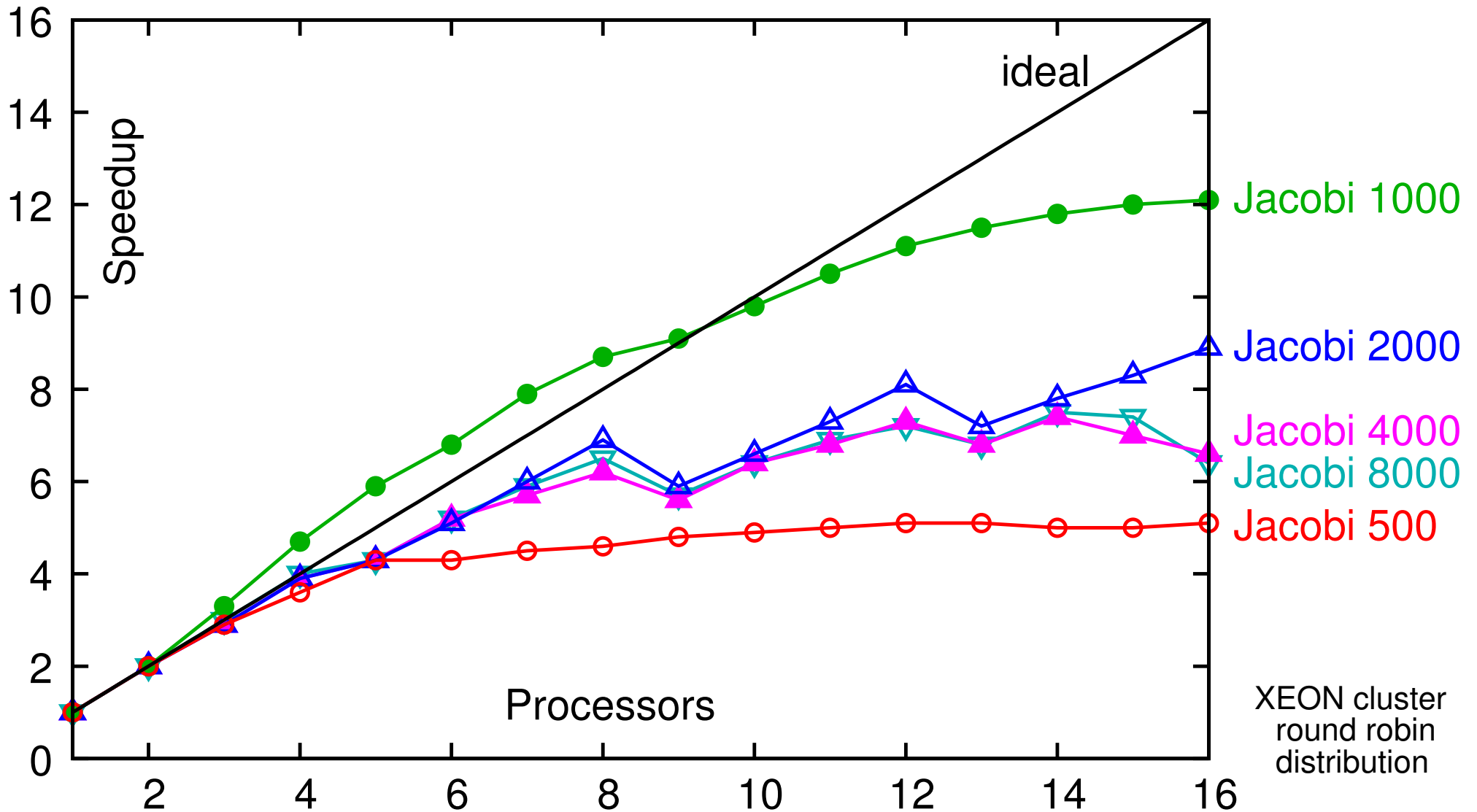



Obtained speedup for different matrix sizes

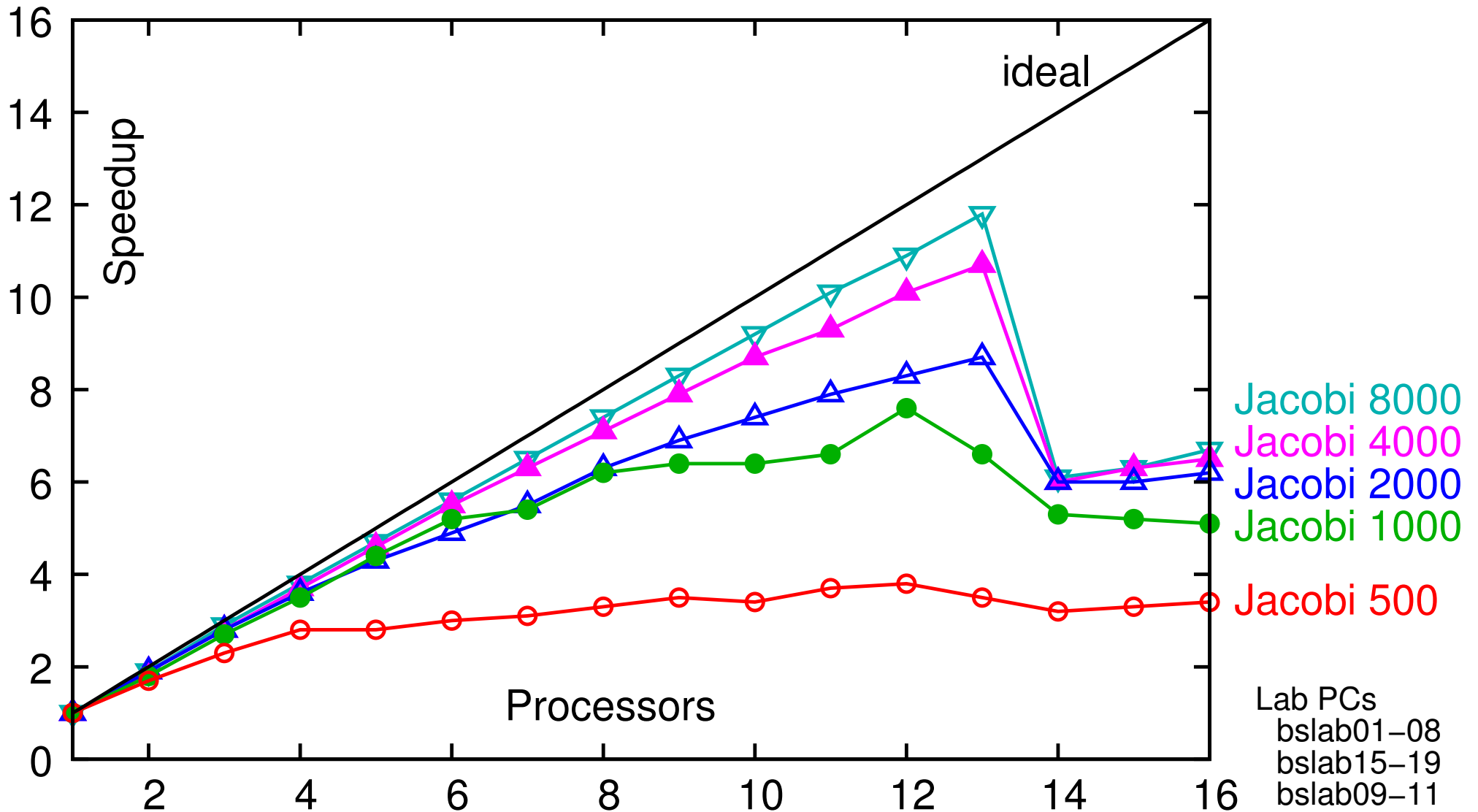



Obtained speedup for different matrix sizes

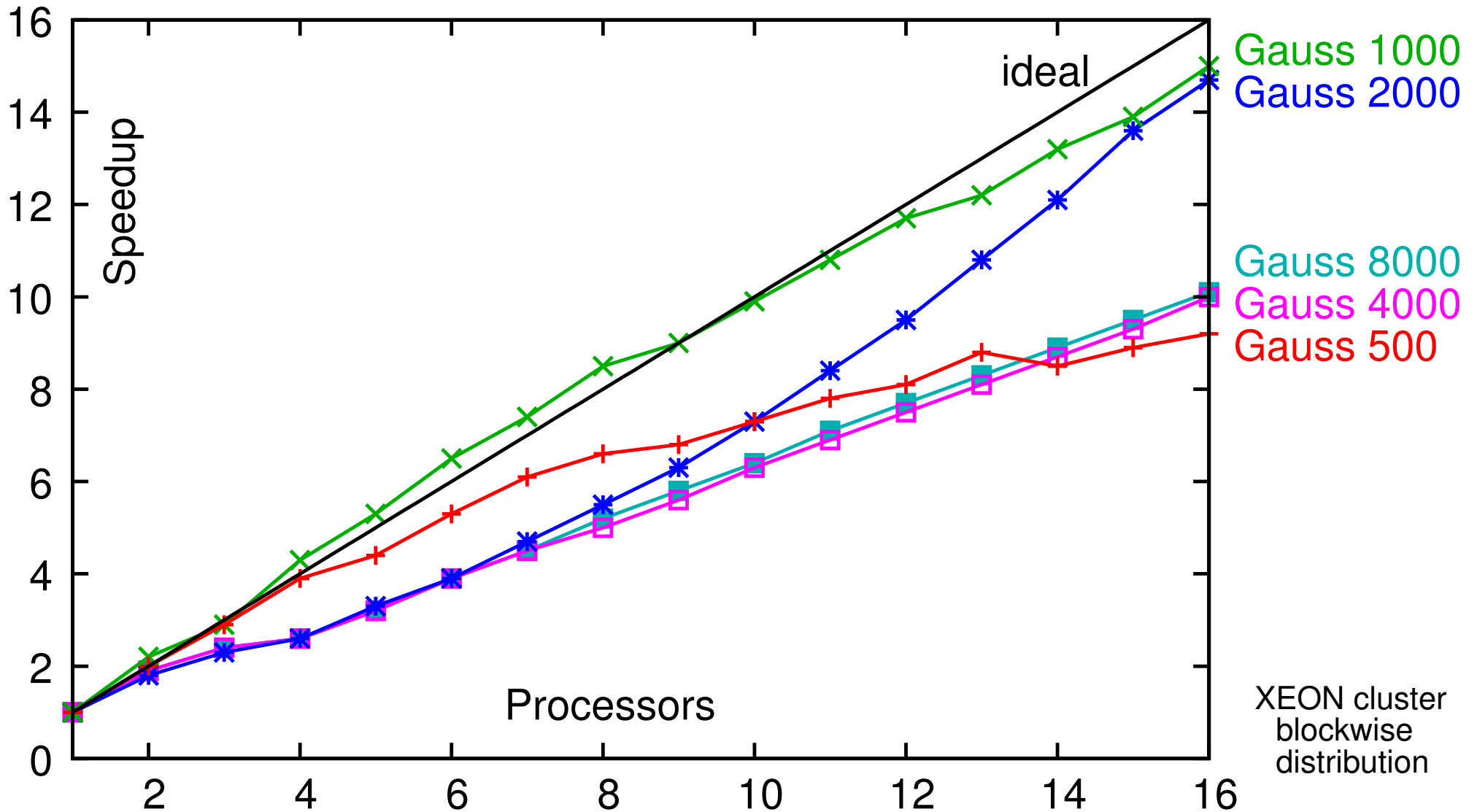



Obtained speedup for different matrix sizes

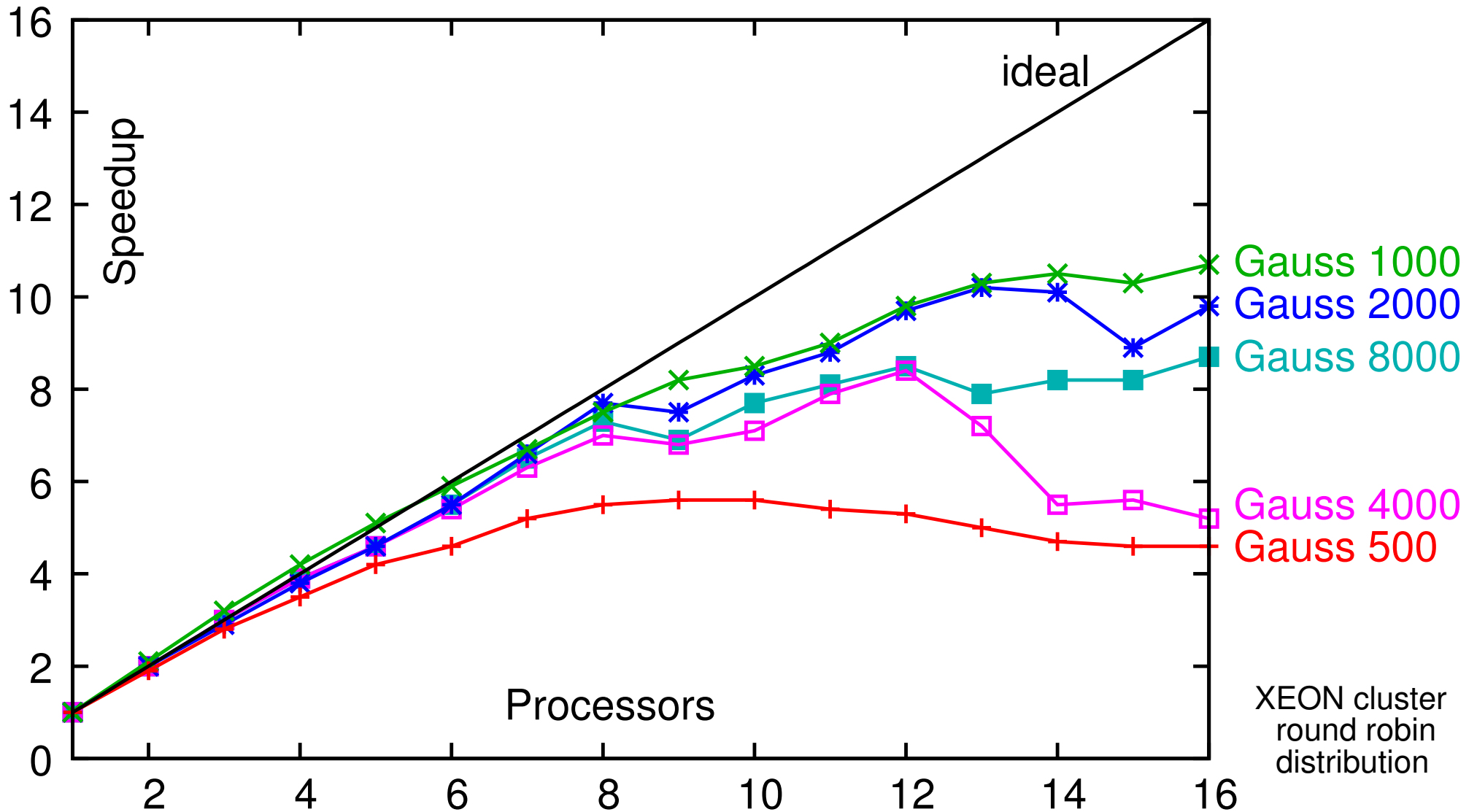



Obtained speedup for different matrix sizes

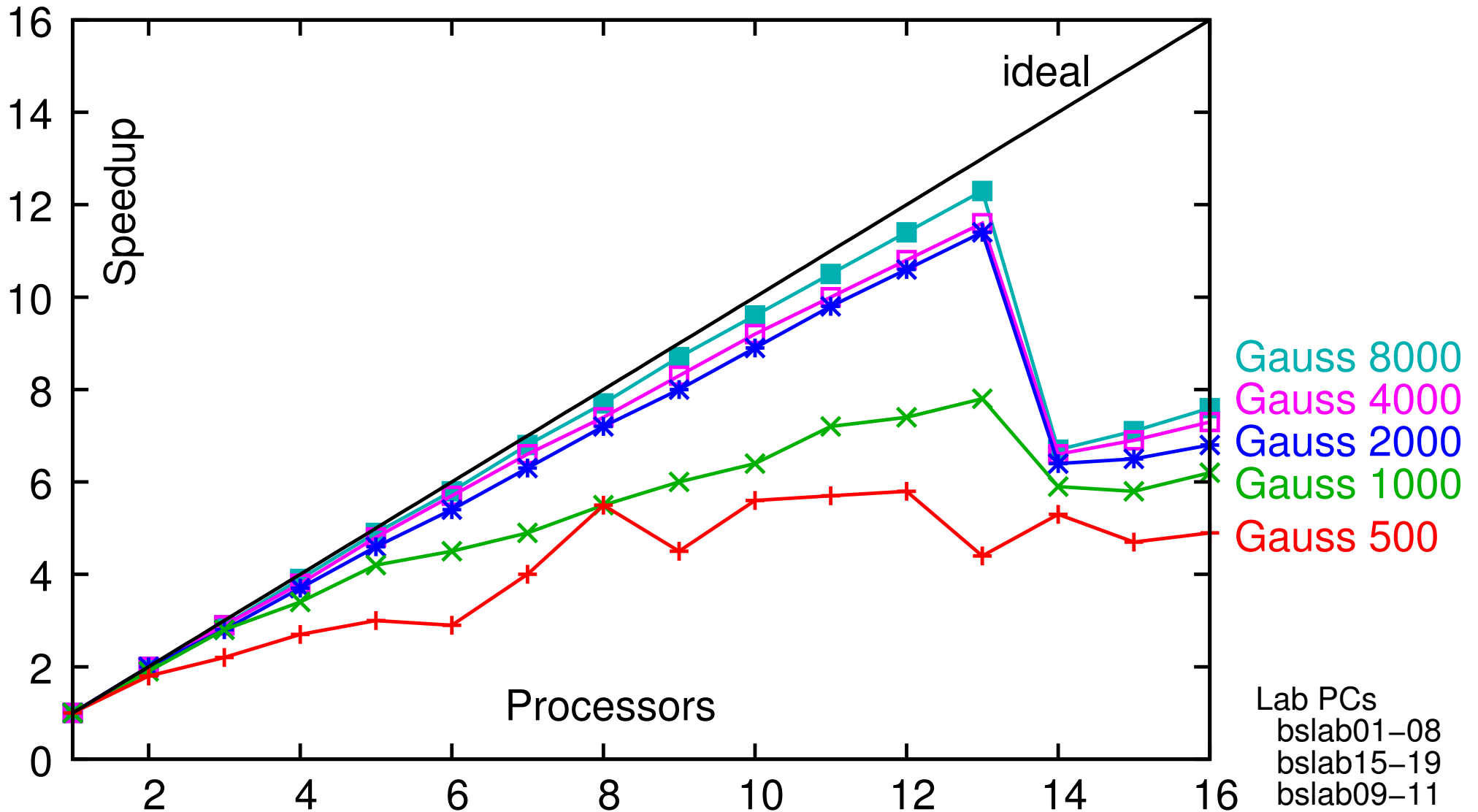



Speedup on the Horus cluster: Jacobi, 1 node

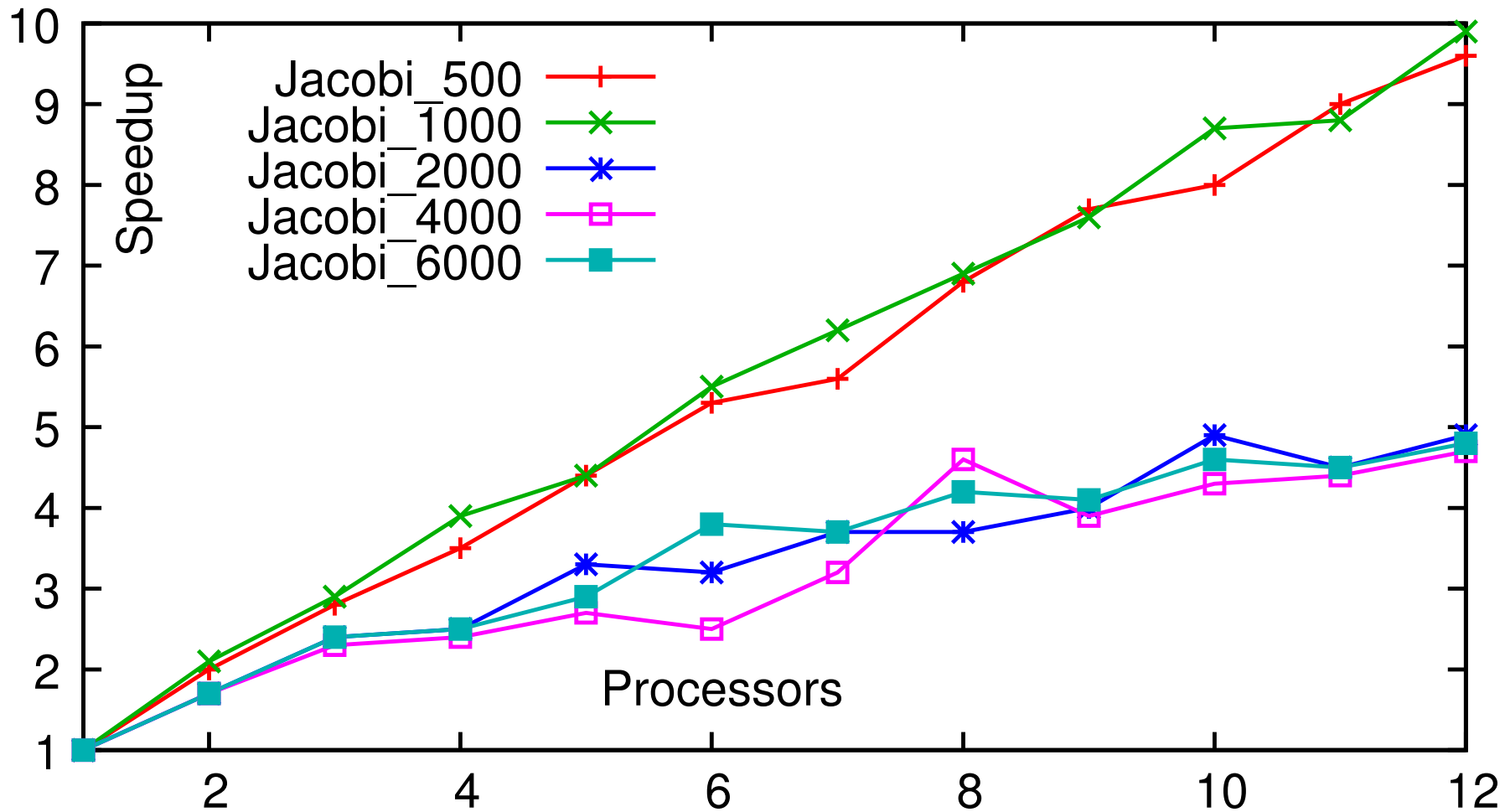

5.5 Exercise: Jacobi and Gauss/Seidel with MPI ...



Speedup on the Horus cluster: Jacobi, 2 processes/node

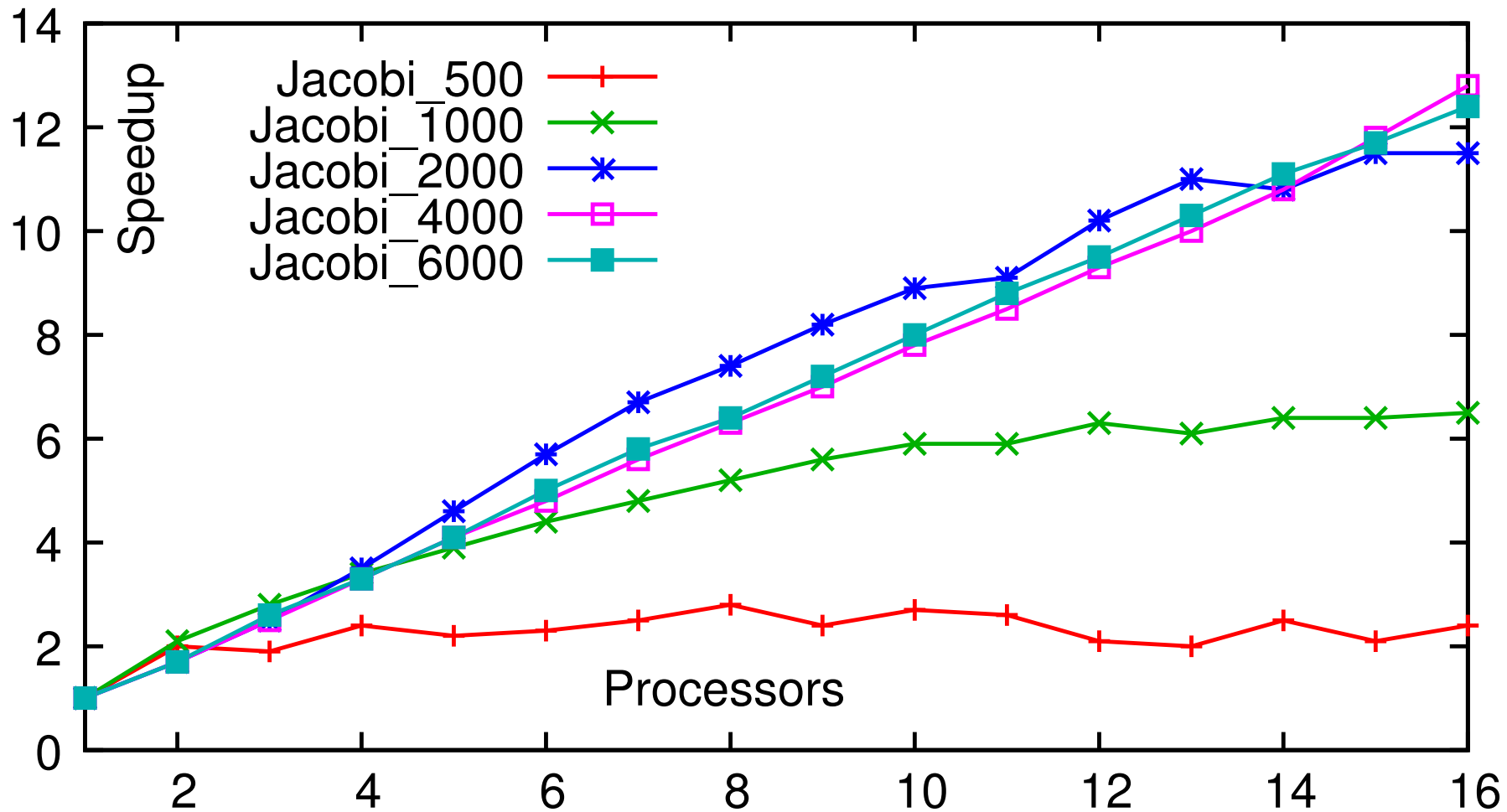



Speedup on the Horus cluster: Gauss/Seidel, 1 node

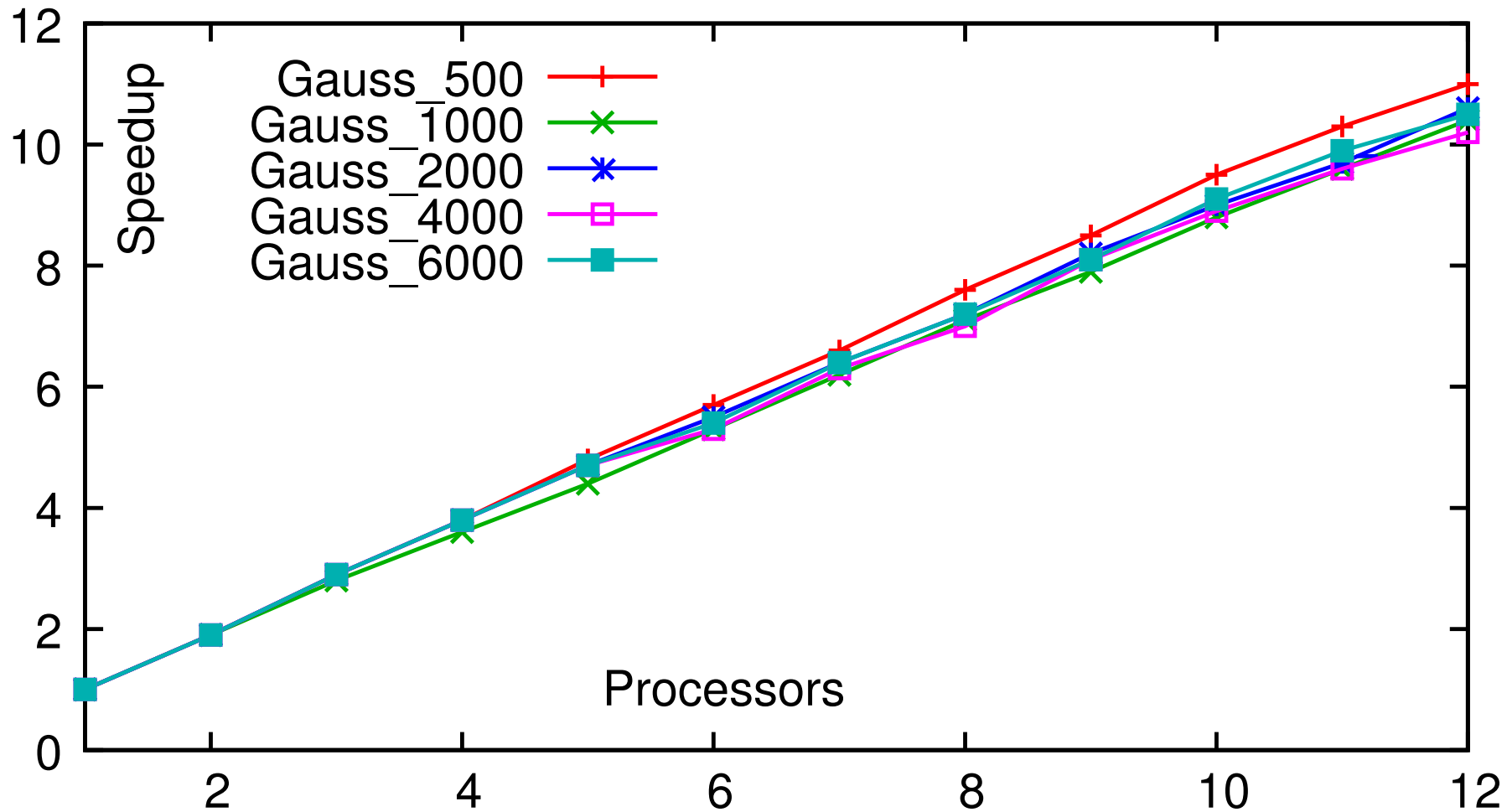



Speedup on the Horus cluster: Gauss/Seidel, 2 processes/node

