Parallel Processing

WS 2017/18

Roland Wismüller
Universität Siegen
roland.wismueller@uni-siegen.de
Tel.: 0271/740-4050, Büro: H-B 8404

Stand: January 15, 2018

Parallel Processing

WS 2017/18

2 Parallel Programming with Shared Memory



Inhalt

- ➔ Basics
- ➔ Posix threads
- ➔ OpenMP basics
- ➔ Loop parallelization and dependences
- ➔ OpenMP synchronization
- ➔ OpenMP details

Literature

- ➔ Wilkinson/Allen, Ch. 8.4, 8.5, Appendix C
- ➔ Hoffmann/Lienhart



Approaches to programming with threads

- ➔ Using (system) libraries
 - ➔ Examples: POSIX threads (👉 **2.2**), Intel Threading Building Blocks (TBB), C++ boost threads
- ➔ As part of a programming language
 - ➔ Examples: Java threads (👉 **BS-I**), C++11
- ➔ Using compiler directives (pragmas)
 - ➔ Examples: OpenMP (👉 **2.3**)

2.1.1 Synchronization

- ➔ Ensuring conditions on the possible sequences of events in threads
 - ➔ mutual exclusion
 - ➔ temporal order of actions in different threads
- ➔ Tools:
 - ➔ shared variables
 - ➔ semaphores / mutexes
 - ➔ monitors / condition variables
 - ➔ barriers

Parallel Processing

WS 2017/18

30.10.2017

Roland Wismüller
Universität Siegen
roland.wismueller@uni-siegen.de
Tel.: 0271/740-4050, Büro: H-B 8404

Stand: January 15, 2018



Synchronization using shared variables

➔ Example: waiting for a result

Thread 1

```
// compute and  
// store result  
ready = true;  
...
```

Thread 2

```
while (!ready); // wait  
// read / process the result  
...
```

➔ Extension: atomic *read-modify-write* operations of the CPU

➔ e.g., *test-and-set*, *fetch-and-add*

➔ Potential drawback: *busy waiting*

➔ but: in high performance computing we often have exactly one thread per CPU ⇒ performance advantage, since no system call



Semaphores

- ➔ Components: counter, queue of blocked threads
- ➔ **atomic** operations:
 - ➔ P() (also acquire, wait or down)
 - ➔ decrements the counter by 1
 - ➔ if counter < 0 : block the thread
 - ➔ V() (also release, signal or up)
 - ➔ increments counter by 1
 - ➔ if counter ≤ 0 : wake up one blocked thread
- ➔ **Binary semaphore**: can only assume the values 0 and 1
 - ➔ usually for mutual exclusion

Monitors

- ➔ Module with data, procedures and initialization code
 - ➔ access to data only via the monitor procedures
 - ➔ (roughly corresponds to a class)
- ➔ All procedures are under mutual exclusion
- ➔ Further synchronization via **condition variables**
 - ➔ two operations:
 - ➔ `wait()`: blocks the calling thread
 - ➔ `signal()`: wakes up some blocked threads
 - ➔ variants: wake up only one thread / wake up all thread
 - ➔ no “memory”: `signal()` only wakes a thread, if it already has called `wait()` before

Barrier

- ➔ Synchronization of groups of processes or threads, respectively
- ➔ Semantics:
 - ➔ thread which reaches the barrier is blocked, until all other threads have reached the barrier, too

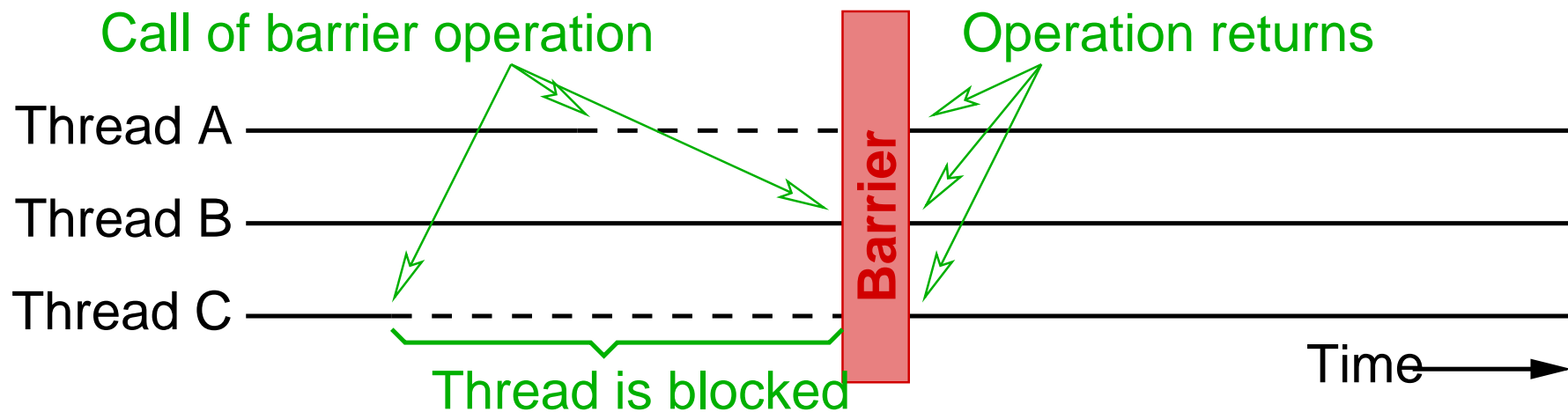

- ➔ Used to structure concurrent applications into synchronous phases



2.1.2 Synchronization errors

- ➔ Insufficient synchronization: *race conditions*
 - ➔ result of the calculation is different (or false), depending on temporal interleaving of the threads
 - ➔ important: do not assume FIFO semantics of the queues in synchronization constructs!

- ➔ Deadlocks
 - ➔ a group of threads waits for conditions, which can only be fulfilled by the other threads in this group

- ➔ Starvation (unfairness)
 - ➔ a thread waiting for a condition can never execute, although the condition is fulfilled regularly



Example for *race conditions*

- ➔ Task: synchronize two threads, such that they print something alternatingly
- ➔ **Wrong** solution with semaphores:

```
Semaphore s1 = 1;  
Semaphore s2 = 0;
```

Thread 1

```
while (true) {  
    P(s1);  
    print("1");  
    V(s2);  
    V(s1);  
}
```

Thread 2

```
while (true) {  
    P(s2);  
    P(s1);  
    print("2");  
    V(s1);  
}
```



2.1.3 Lock-Free and Wait-Free Data Structures

- ➔ Goal: Data structures (typically *collections*) without mutual exclusion
 - ➔ more performant, no danger of deadlocks
- ➔ *Lock-free*: under **any circumstances** at least one of the threads makes progress after a finite number of steps
 - ➔ in addition, *wait-free* also prevents starvation
- ➔ Typical approach:
 - ➔ use atomic *read-modify-write* instructions instead of locks
 - ➔ in case of conflict, i.e., when there is a simultaneous change by another thread, the affected operation is repeated



Example: appending to an array (at the end)

```
int fetch_and_add(int* addr, int val) {  
    int tmp = *addr;  
    *addr += val;  
    return tmp;  
}
```

} **Atomic!**

```
Data buffer[N]; // Buffer array  
int wrPos = 0; // Position of next element to be inserted
```

```
void add_last(Data data) {  
    int wrPosOld = fetch_and_add(&wrPos, 1);  
    buffer[wrPosOld] = data;  
}
```



Example: prepend to a linked list (at the beginning)

```
bool compare_and_swap(void* addr, void* exp, void* new) {  
    if (*addr == *exp) {  
        *addr = *new;  
        return true;  
    }  
    return false;  
}
```

} **Atomic!**

```
Element* firstNode = NULL; // Pointer to first element
```

```
void add_first(Element* node) {  
    Element* tmp;  
    do {  
        tmp = firstNode;  
        node->next = tmp;  
    } while (!compare_and_swap(firstNode, tmp, node));  
}
```



- ➔ Problems
 - ➔ re-use of memory addresses can result in corrupt data structures
 - ➔ assumption in linked list: if `firstNode` is still unchanged, the list was not accessed concurrently
 - ➔ thus, we need special procedures for memory deallocation
- ➔ There is a number of libraries for C++ and also for Java
 - ➔ C++: e.g., `boost.lockfree`, `libcds`, Concurrency Kit, `liblfd`s
 - ➔ Java: e.g., Amino Concurrent Building Blocks, Highly Scalable Java
- ➔ Compilers usually offer *read-modify-write* operations
 - ➔ e.g., `gcc/g++`: built-in functions `__sync_...()`

2.2 POSIX Threads (PThreads)



- ➔ IEEE 1003.1c: standard interface for programming with threads
 - ➔ implemented by a system library
 - ➔ (mostly) independent of operating system
- ➔ Programming model:
 - ➔ at program start: exactly one (master) thread
 - ➔ master thread creates other threads and should usually wait for them to finish
 - ➔ process terminates when master thread terminates



Functions for thread management (incomplete)

```
➔ int pthread_create(pthread_t *thread,  
                    pthread_attr_t *attr,  
                    void *(*start_routine)(void *),  
                    void *arg)
```

➔ creates a new thread

➔ input parameters:

➔ `attr`: thread attributes

➔ `start_routine`: function that should be executed by the thread

➔ `arg`: parameter, which is passed to `start_routine`

➔ Result:

➔ `*thread`: thread *handle* (= reference)



Functions for thread management ...

➔ `void pthread_exit(void *retval)`

➔ calling thread will exit (with return value `retval`)

➔ `int pthread_cancel(pthread_t thread)`

➔ terminates the specified thread

➔ termination can only occur at specific places in the code

➔ before termination, a *cleanup handler* is called, if defined

➔ termination can be masked

➔ `int pthread_join(pthread_t th, void **thread_return)`

➔ waits for the specified thread to terminate

➔ returns the result value in `*thread_return`

2.2 POSIX Threads (PThreads) ...



Example: Hello world (👉 02/helloThread.cpp)

```
#include <pthread.h>
```

```
void * SayHello(void *arg) {  
    cout << "Hello World!\n";  
    return NULL;  
}
```

```
int main(int argc, char **argv) {  
    pthread_t t;  
    if (pthread_create(&t, NULL, SayHello, NULL) != 0) {  
        /* Error! */  
    }  
    pthread_join(t, NULL);  
    return 0;  
}
```

2.2 POSIX Threads (PThreads) ...



Example: Summation of an array with multiple threads

(👉 02/sum.cpp)

```
#include <pthread.h>
```

```
#define N 5
```

```
#define M 1000
```

```
/* This function is called by each thread */
```

```
void *sum_line(void *arg)
```

```
{
```

```
    int *line = (int *)arg;
```

```
    int i;
```

```
    long sum = 0;
```

```
    for (i=0; i<M; i++)
```

```
        sum += line[i];
```

```
    return (void *)sum;    /* return the sum, finished. */
```

```
}
```

2.2 POSIX Threads (PThreads) ...



```
/* Initialize the array */
```

```
void init_array(int array[N][M])  
{  
    ...  
}
```

```
/* Main program */
```

```
int main(int argc, char **argv)  
{  
    int array[N][M];  
    pthread_t threads[N];  
    int i;  
    void *result;  
    long sum = 0;  
  
    init_array(array);    /* initialize the array */
```

2.2 POSIX Threads (PThreads) ...



```
/* Create a thread for each line, with a pointer to the line as parameter */
/* Caution: error checks and thread attributes are missing! */
for (i=0; i<N; i++) {
    pthread_create(&threads[i], NULL, sum_line, array[i]);
}

/* Wait for termination, sum up the results */
for (i=0; i<N; i++) {
    pthread_join(threads[i], &result);
    sum += (long)result;
}

cout << "Sum: " << sum << "\n";
}
```

Compile and link the program

```
➔ g++ -o sum sum.cpp -pthread
```



Remarks on the example

- ➔ PThreads only allows to pass *one* argument
 - ➔ usually, a pointer to an argument data structure
 - ➔ pointer to a local variable is only allowed, if `pthread_join` is called within the same procedure!
- ➔ The return value of a thread is `void *`
 - ➔ ugly type conversion
 - ➔ with multiple return values: pointer to a data structure (allocated globally or dynamically)
- ➔ No synchronization is required
- ➔ `pthread_join` can only wait for a specific thread
 - ➔ inefficient, when threads have different execution times



Synchronization: mutex variables

- ➔ Behavior similar to binary semaphore
 - ➔ states: locked, unlocked; initial state: unlocked
- ➔ Declaration and initialization (global/static variable):

```
pthread_mutex_t mutex = PTHREAD_MUTEX_INITIALIZER;
```
- ➔ Operations:
 - ➔ lock: `pthread_mutex_lock(&mutex)`
 - ➔ behavior for recursive locking is not specified
 - ➔ unlocked: `pthread_mutex_unlock(&mutex)`
 - ➔ when a thread terminates, its mutexes are **not** automatically unlocked!
 - ➔ try locking: `pthread_mutex_trylock(&mutex)`
 - ➔ does not block; returns an error code, if applicable



Synchronization: condition variables

➔ Declaration and initialization (global/static variable):

```
pthread_cond_t cond = PTHREAD_COND_INITIALIZER;
```

➔ Operations:

➔ wait: `pthread_cond_wait(&cond, &mutex)`

➔ thread is blocked, `mutex` will be unlocked temporarily

➔ signaling thread keeps the `mutex`, i.e., the condition may no longer be fulfilled when the routine returns!

➔ typical use:

```
while (!condition_met)
    pthread_cond_wait(&cond, &mutex);
```

➔ signal:

➔ to a single thread: `pthread_cond_signal(&cond)`

➔ to all threads: `pthread_cond_broadcast(&cond)`



Example: simulating a monitor with PThreads

```
#include <pthread.h>                                     (👉 02/monitor.cpp)

pthread_mutex_t mutex = PTHREAD_MUTEX_INITIALIZER;
pthread_cond_t  cond  = PTHREAD_COND_INITIALIZER;
volatile int ready = 0;
volatile int result;

void StoreResult(int arg)
{
    pthread_mutex_lock(&mutex);
    result = arg; /* store result */
    ready = 1;
    pthread_cond_broadcast(&cond);
    pthread_mutex_unlock(&mutex);
}
```



Example: simulating a monitor with PThreads ...

```
int ReadResult()  
{  
    int tmp;  
    pthread_mutex_lock(&mutex);  
    while (ready != 1)  
        pthread_cond_wait(&cond, &mutex);  
    tmp = result; /* read result */  
    pthread_mutex_unlock(&mutex);  
    return tmp;  
}
```

- ➔ `while` is important, since the waiting thread unlocks the `mutex`
- ➔ another thread could destroy the condition again before the waiting thread regains the `mutex`
(although this cannot happen in this concrete example!)



Background

- ➔ Thread libraries (for FORTRAN and C) are often too complex (and partially system dependent) for application programmers
 - ➔ wish: more abstract, portable constructs
- ➔ OpenMP is an inofficial standard
 - ➔ since 1997 by the OpenMP forum (www.openmp.org)
- ➔ API for parallel programming with shared memory using FORTRAN / C / C++
 - ➔ **source code directives**
 - ➔ library routines
 - ➔ environment variables
- ➔ Besides parallel processing with threads, OpenMP also supports SIMD extensions and external accelerators (since version 4.0)

Parallel Processing

WS 2017/18

06.11.2017

Roland Wismüller
Universität Siegen
roland.wismueller@uni-siegen.de
Tel.: 0271/740-4050, Büro: H-B 8404

Stand: January 15, 2018



Parallelization using directives

- ➔ The programmer must specify
 - ➔ which code regions should be executed in parallel
 - ➔ where a synchronization is necessary
- ➔ This specification is done using **directives (pragmas)**
 - ➔ special control statements for the compiler
 - ➔ unknown directives are ignored by the compiler
- ➔ Thus, a program with OpenMP directives can be compiled
 - ➔ with an OpenMP compiler, resulting in a parallel program
 - ➔ with a standard compiler, resulting in a sequential program



Parallelization using directives ...

- ➔ Goal of parallelizing with OpenMP:
 - ➔ distribute the execution of sequential program code to several threads, without changing the code
 - ➔ identical source code for sequential and parallel version
- ➔ Three main classes of directives:
 - ➔ directives for creating threads (`parallel`, `parallel region`)
 - ➔ within a parallel region: directives to distribute the work to the individual threads
 - ➔ data parallelism: distribution of loop iterations (`for`)
 - ➔ task parallelism: parallel code regions (`sections`) and explicit tasks (`task`)
 - ➔ directives for synchronization



Parallelization using directives: discussion

- ➔ Compromise between
 - ➔ completely manual parallelization (as, e.g., with MPI)
 - ➔ automatic parallelization by the compiler
- ➔ Compiler takes over the organization of the parallel tasks
 - ➔ thread creation, distribution of tasks, ...
- ➔ Programmer takes over the necessary dependence analysis
 - ➔ which code regions can be executed in parallel?
 - ➔ enables detailed control over parallelism
 - ➔ but: programmer is responsible for correctness

2.3.1 The parallel directive



An example (👉 02/firstprog.cpp)

Program

```
main() {  
    cout << "Serial\n";  
  
    {  
        cout << "Parallel\n";  
    }  
    cout << "Serial\n";  
}
```

2.3.1 The `parallel` directive



An example (👉 02/firstprog.cpp)

Program

```
main() {  
    cout << "Serial\n";  
    #pragma omp parallel  
    {  
        cout << "Parallel\n";  
    }  
    cout << "Serial\n";  
}
```

Compilation

```
g++ -fopenmp -o tst  
    firstprog.cpp
```

2.3.1 The parallel directive



An example (👉 02/firstprog.cpp)

Program

```
main() {  
    cout << "Serial\n";  
    #pragma omp parallel  
    {  
        cout << "Parallel\n";  
    }  
    cout << "Serial\n";  
}
```

Compilation

```
g++ -fopenmp -o tst  
    firstprog.cpp
```

Execution

```
% export OMP_NUM_THREADS=2  
% ./tst  
Serial  
Parallel  
Parallel  
Serial
```

```
% export OMP_NUM_THREADS=3  
% ./tst  
Serial  
Parallel  
Parallel  
Parallel  
Serial
```

2.3.1 The parallel directive ...



Execution model: fork/join

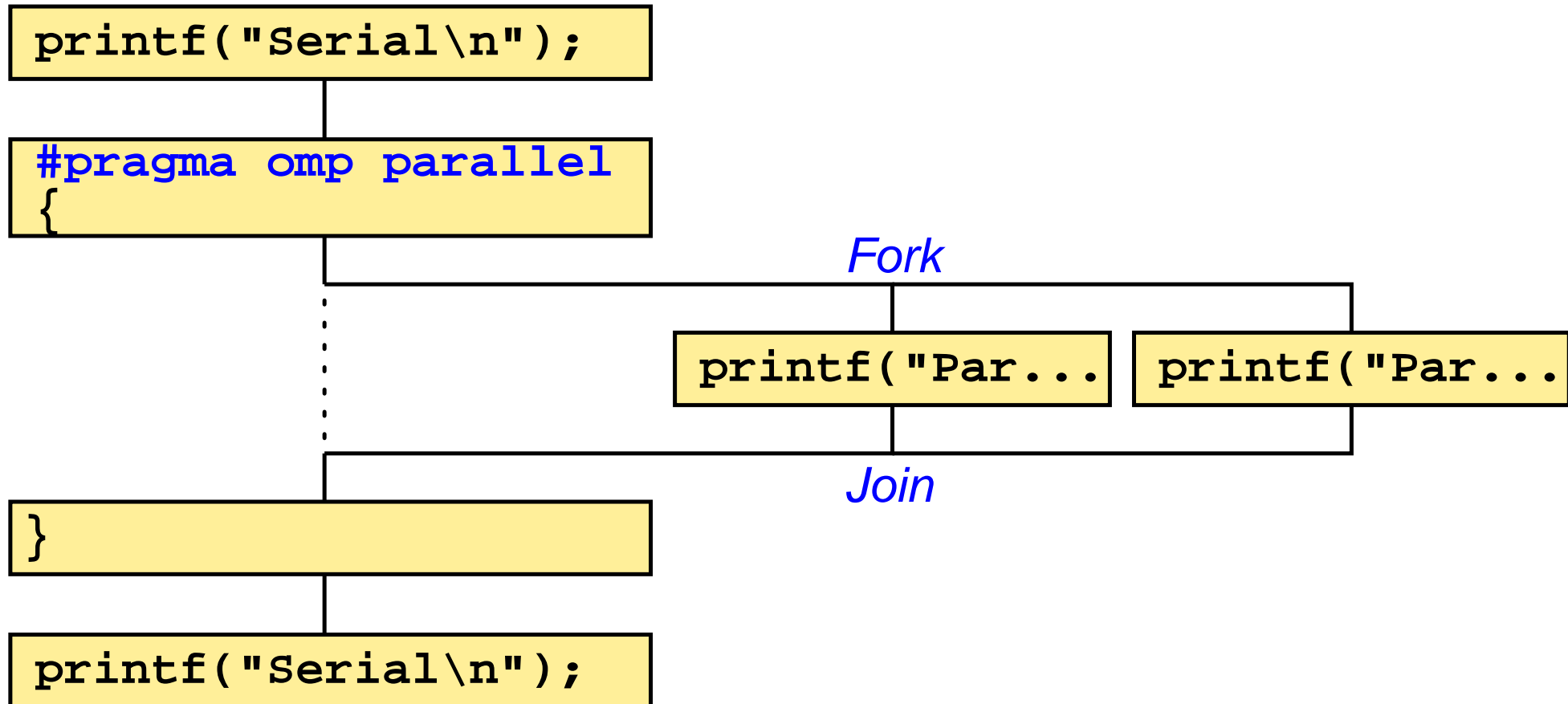



Execution model: `fork/join` ...

- ➔ Program starts with exactly one *master* thread
- ➔ When a parallel region (`#pragma omp parallel`) is reached, additional threads will be created (fork)
 - ➔ environment variable `OMP_NUM_THREADS` specifies the total number of threads in the **team**
- ➔ The parallel region is executed by all threads in the team
 - ➔ at first redundantly, but additional OpenMP directives allow a partitioning of tasks
- ➔ At the end of the parallel region:
 - ➔ all threads terminate, except the master thread
 - ➔ master thread waits, until all other threads have terminated (join)

Syntax of directives (in C / C++)

➔ `#pragma omp <directive> [<clause_list>]`

➔ `<clause_list>`: List of options for the directive

➔ Directive only affects the immediately following statement or the immediately following block, respectively

➔ **static extent** (*statischer Bereich*) of the directive

```
#pragma omp parallel
cout << "Hello\n";      // parallel
cout << "Hi there\n";  // sequential again
```

➔ **dynamic extent** (*dynamischer Bereich*) of a directive

➔ also includes the functions being called in the static extent (which thus are also executed in parallel)



Shared and private variables

- ➔ For variables in a parallel region there are two alternatives
 - ➔ the variable is shared by all threads (*shared variable*)
 - ➔ all threads access the same variable
 - ➔ usually, some synchronization is required!
 - ➔ each thread has its own private instance (*private variable*)
 - ➔ can be initialized with the value in the master thread
 - ➔ value is dropped at the end of the parallel region
- ➔ For variables, which are declared **within** the dynamic extent of a `parallel` directive, the following holds:
 - ➔ local variables are private
 - ➔ static variables and heap variables (`new`) are shared



Shared and private variables ...

- ➔ For variables, which have been declared **before entering** a parallel region, the behavior can be specified by an option of the `parallel` directive:
 - ➔ `private (<variable_list>)`
 - ➔ private variable, without initialization
 - ➔ `firstprivate (<variable_list>)`
 - ➔ private variable
 - ➔ initialized with the value in the master thread
 - ➔ `shared (<variable_list>)`
 - ➔ shared variable
 - ➔ shared is the default for all variables

2.3.1 The parallel directive ...



Shared and private variables: an example (👉 02/private.cpp)

Each thread has a
(non-initialized) copy of i

Each thread has an
initialized copy of j

```
int i = 0, j = 1, k = 2;
#pragma omp parallel private(i) firstprivate(j)
{
    int h = random() % 100;
    cout << "P: i=" << i << ", j=" << j
         << ", k=" << k << ", h=" << h << "\n";
    i++; j++; k++;
}
cout << "S: i=" << i << ", j=" << j
     << ", k=" << k << "\n";
```

h ist privat

Accesses to
k usually
should be
synchronized!

Output (with 2 threads):

```
P: i=1023456, j=1, k=2, h=86
P: i=-123059, j=1, k=3, h=83
S: i=0, j=1, k=4
```



- ➔ OpenMP also defines some library routines, e.g.:
 - ➔ `int omp_get_num_threads()`: returns the number of threads
 - ➔ `int omp_get_thread_num()`: returns the thread number
 - ➔ between 0 (master thread) and `omp_get_num_threads()-1`
 - ➔ `int omp_get_num_procs()`: number of processors (cores)
 - ➔ `void omp_set_num_threads(int nthreads)`
 - ➔ defines the number of threads (maximum is `OMP_NUM_THREADS`)
 - ➔ `double omp_get_wtime()`: wall clock time in seconds
 - ➔ for runtime measurements
 - ➔ in addition: functions for mutex locks
- ➔ When using the library routines, the code can, however, no longer be compiled without OpenMP ...



Example using library routines (👉 02/threads.cpp)

```
#include <omp.h>
int me;
omp_set_num_threads(2);           // use only 2 threads
#pragma omp parallel private(me)
{
    me = omp_get_thread_num();    // own thread number (0 or 1)
    cout << "Thread " << me << "\n";
    if (me == 0)                  // threads execute different code!
        cout << "Here is the master thread\n";
    else
        cout << "Here is the other thread\n";
}
```

➡ In order to use the library routines, the header file `omp.h` must be included



Motivation

- ➔ Implementation of data parallelism
 - ➔ threads perform identical computations on different parts of the data
- ➔ Two possible approaches:
 - ➔ primarily look at the data and distribute them
 - ➔ distribution of computations follows from that
 - ➔ e.g., with HPF or MPI
 - ➔ primarily look at the computations and distribute them
 - ➔ computations virtually always take place in loops (⇒ loop parallelization)
 - ➔ no explicit distribution of data
 - ➔ for programming models with shared memory

2.4.1 The `for` directive: parallel loops

```
#pragma omp for [<clause_list>]  
for(...) ...
```

- ➔ Must only be used within the dynamic extent of a `parallel` directive
- ➔ Execution of loop iterations will be distributed to all threads
 - ➔ loop variables automatically is private
- ➔ Only allowed for “simple” loops
 - ➔ no `break` or `return`, integer loop variable, ...
- ➔ No synchronization at the beginning of the loop
- ➔ Barrier synchronization at the end of the loop
 - ➔ unless the option `nowait` is specified

2.4.1 The `for` directive: parallel loops ...



Example: vector addition

```
double a[N], b[N], c[N];
int i;
#pragma omp parallel for
for (i=0; i<N; i++) {
    a[i] = b[i] + c[i];
}
```

Short form for
`#pragma omp parallel`
{
 `#pragma omp for`
 ...
}

- ➔ Each thread processes a part of the vector
 - ➔ data partitioning, data parallel model
- ➔ Question: exactly how will the iterations be distributed to the threads?
 - ➔ can be specified using the `schedule` option
 - ➔ default: with n threads, thread 1 gets the first n -th of the iterations, thread 2 the second n -th, ...



Scheduling of loop iterations

- ➔ Option `schedule(<class> [, <size>])`
- ➔ Scheduling classes:
 - ➔ `static`: blocks of given size (optional) are distributed to the threads in a round-robin fashion, before the loop is executed
 - ➔ `dynamic`: iterations are distributed in blocks of given size, execution follows the work pool model
 - ➔ better load balancing, if iterations need a different amount of time for processing
 - ➔ `guided`: like `dynamic`, but block size is decreasing exponentially (smallest block size can be specified)
 - ➔ better load balancing as compared to equal sized blocks
 - ➔ `auto`: determined by the compiler / run time system
 - ➔ `runtime`: specification via environment variable

2.4.1 The for directive: parallel loops ...



Scheduling example (👉 02/loops.cpp)

```
int i, j;
double x;

#pragma omp parallel for private(i,j,x) schedule(runtime)
for (i=0; i<40000; i++) {
    x = 1.2;
    for (j=0; j<i; j++) {           // triangular loop
        x = sqrt(x) * sin(x*x);
    }
}
```

➡ Scheduling can be specified at runtime, e.g.:

➡ `export OMP_SCHEDULE="static,10"`

➡ Useful for optimization experiments



Scheduling example: results

➔ Runtime with 4 threads on the lab computers:

OMP_SCHEDULE	"static"	"static,1"	"dynamic"	"guided"
Time	3.1 s	1.9 s	1.8 s	1.8 s

➔ Load imbalance when using "static"

➔ thread 1: $i=0..9999$, thread 4: $i=30000..39999$

➔ "static,1" and "dynamic" use a block size of 1

➔ each thread executes every 4th iteration of the i loop

➔ can be very inefficient due to caches (*false sharing*, 📌 4.1)

➔ remedy: use larger block size (e.g.: "dynamic,100")

➔ "guided" often is a good compromise between load balancing and locality (cache usage)



Shared and private variables in loops

- ➔ The `for` directive can be supplemented with the options `private`, `shared` and `firstprivate` (see slide 179 ff.)
- ➔ In addition, there is an option `lastprivate`
 - ➔ private variable
 - ➔ after the loop, the master thread has the value of the last iteration

➔ Example:

```
int i = 0;
#pragma omp parallel for lastprivate(i)
for (i=0; i<100; i++) {
    ...
}
printf("i=%d\n", i); // prints the value 100
```

2.4.2 Parallelization of Loops



When can a loop be parallelized?

```
for(i=1;i<N;i++)  
  a[i] = a[i]  
    + b[i-1];
```

```
for(i=1;i<N;i++)  
  a[i] = a[i-1]  
    + b[i];
```

```
for(i=0;i<N;i++)  
  a[i] = a[i+1]  
    + b[i];
```

- ➔ Optimal: independent loops (**forall** loop)
 - ➔ loop iterations can be executed concurrently without any synchronization
 - ➔ there must not be any dependences between statements in **different** loop iterations
 - ➔ (equivalent: the statements in different iterations must fulfill the **Bernstein conditions**)

2.4.2 Parallelization of Loops



When can a loop be parallelized?

```
for(i=1;i<N;i++)  
  a[i] = a[i]  
    + b[i-1];
```

No dependence

```
for(i=1;i<N;i++)  
  a[i] = a[i-1]  
    + b[i];
```

True dependence

```
for(i=0;i<N;i++)  
  a[i] = a[i+1]  
    + b[i];
```

Anti dependence

- ➔ Optimal: independent loops (**forall** loop)
 - ➔ loop iterations can be executed concurrently without any synchronization
 - ➔ there must not be any dependences between statements in **different** loop iterations
 - ➔ (equivalent: the statements in different iterations must fulfill the **Bernstein conditions**)

Handling of data dependences in loops

- ➔ Anti and output dependences:
 - ➔ can always be removed, e.g., by consistent renaming of variables
 - ➔ in the previous example:

```
#pragma omp parallel
{
    #pragma omp for
    for(i=1;i<=N;i++)
        a2[i] = a[i];
    #pragma omp for
    for(i=0;i<N;i++)
        a[i] = a2[i+1] + b[i];
}
```

- ➔ the barrier at the end of the first loop is necessary!



Handling of data dependences in loops ...

➔ True dependence:

➔ introduce proper synchronization between the threads

➔ e.g., using the ordered directive (☞ **2.6**):

```
#pragma omp parallel for ordered
for (i=1;i<N;i++) {
    // long computation of b[i]
    #pragma omp ordered
    a[i] = a[i-1] + b[i];
}
```

➔ disadvantage: degree of parallelism often is largely reduced

➔ sometimes, a vectorization (SIMD) is possible (☞ **2.8.2**), e.g.:

```
#pragma omp simd safelen(4)
for (i=4;i<N;i++)
    a[i] = a[i-4] + b[i];
```

2.4.3 Simple Examples



Matrix addition

```
double a[N][N];
double b[N][N];
int i,j;

for (i=0; i<N; i++) {
    for (j=0; j<N; j++) {
        a[i][j] += b[i][j];
    }
}
```

Matrix addition

```
double a[N][N];
double b[N][N];
int i,j;

for (i=0; i<N; i++) {
  for (j=0; j<N; j++) {
    a[i][j] += b[i][j];
  }
}
```

No dependences in 'j' loop:

- 'b' is read only
- Elements of 'a' are always read in the same 'j' iteration, in which they are written

Matrix addition

```
double a[N][N];
double b[N][N];
int i,j;

for (i=0; i<N; i++) {
  for (j=0; j<N; j++) {
    a[i][j] += b[i][j];
  }
}
```

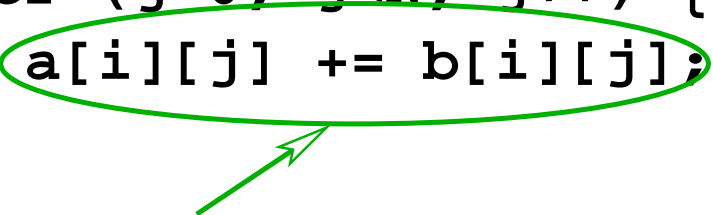

No dependences in 'j' loop:

- 'b' is read only
- Elements of 'a' are always read in the same 'j' iteration, in which they are written

```
double a[N][N];
double b[N][N];
int i,j;

for (i=0; i<N; i++) {
  #pragma omp parallel for
  for (j=0; j<N; j++) {
    a[i][j] += b[i][j];
  }
}
```

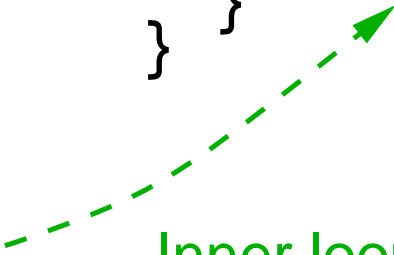

Inner loop can be executed in parallel

Matrix addition

```
double a[N][N];
double b[N][N];
int i,j;

for (i=0; i<N; i++) {
  for (j=0; j<N; j++) {
    a[i][j] += b[i][j];
  }
}
```

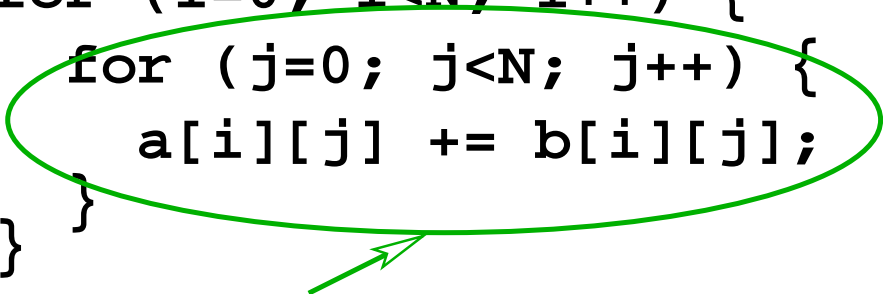

No dependences in 'i' loop:

- 'b' is read only
- Elements of 'a' are always read in the same 'i' iteration, in which they are written

Matrix addition

```
double a[N][N];
double b[N][N];
int i,j;

for (i=0; i<N; i++) {
  for (j=0; j<N; j++) {
    a[i][j] += b[i][j];
  }
}
```

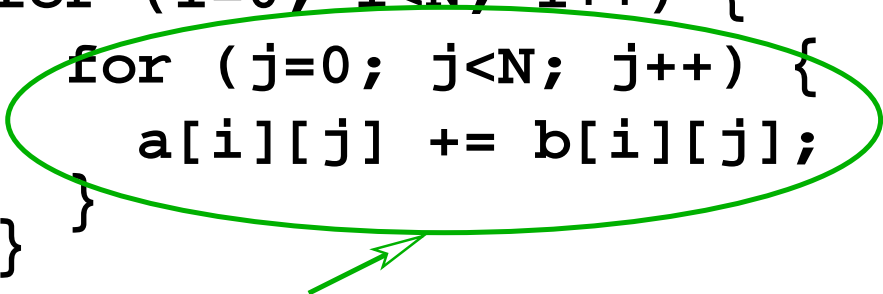

No dependences in 'i' loop:

- 'b' is read only
- Elements of 'a' are always read in the same 'i' iteration, in which they are written

```
double a[N][N];
double b[N][N];
int i,j;

#pragma omp parallel for
private(j)
for (i=0; i<N; i++) {
  for (j=0; j<N; j++) {
    a[i][j] += b[i][j];
  }
}
```

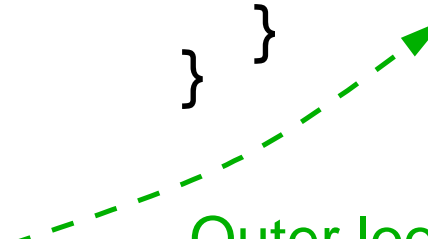

Outer loop can be executed in parallel

Advantage: less overhead!

Parallel Processing

WS 2017/18

13.11.2017

Roland Wismüller
Universität Siegen
roland.wismueller@uni-siegen.de
Tel.: 0271/740-4050, Büro: H-B 8404

Stand: January 15, 2018

Matrix multiplication

```
double a[N][N], b[N][N], c[N][N];
int i,j,k;
for (i=0; i<N; i++) {
    for (j=0; j<N; j++) {
        c[i][j] = 0;
        for (k=0; k<N; k++) {
            c[i][j] = c[i][j] + a[i][k] * b[k][j];
        }
    }
}
```

True dependence in the 'k' loop

No dependences in the 'i' and 'j' loops

- ➔ Both the *i* and the *j* loop can be executed in parallel
- ➔ Usually, the outer loop is parallelized, since the overhead is lower



Removing dependences

```
double a[N], b[N];
int i;
double val = 1.2;
for (i=1; i<N; i++) {
    b[i-1] = a[i] * a[i];
    a[i-1] = val;
}
a[i-1] = b[0];
```



Removing dependences

```
double a[N], b[N];
int i;
double val = 1.2;
for (i=1; i<N; i++) {
    b[i-1] = a[i] * a[i];
    a[i-1] = val;
}
a[i-1] = b[0];
```

Anti depend. between iterations

Removing dependences

```
double a[N], b[N];
int i;
double val = 1.2;
for (i=1; i<N; i++) {
    b[i-1] = a[i] * a[i];
    a[i-1] = val;
}
a[i-1] = b[0];
```

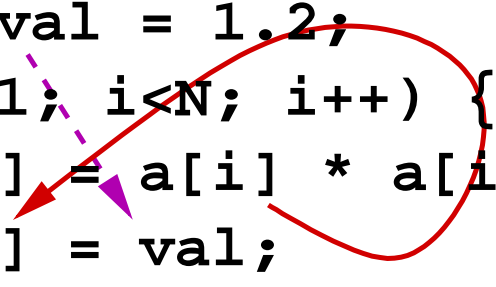

Anti depend. between iterations

True dependece between
loop and environment

Removing dependences

```
double a[N], b[N];
int i;
double val = 1.2;
for (i=1; i<N; i++) {
    b[i-1] = a[i] * a[i];
    a[i-1] = val;
}
a[i-1] = b[0];
```

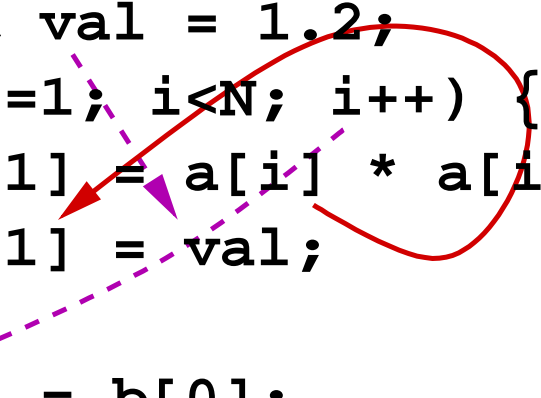

Anti depend. between iterations

True dependece between
loop and environment

Removing dependences

```
double a[N], b[N];
int i;
double val = 1.2;
for (i=1; i<N; i++) {
    b[i-1] = a[i] * a[i];
    a[i-1] = val;
}
a[i-1] = b[0];
```

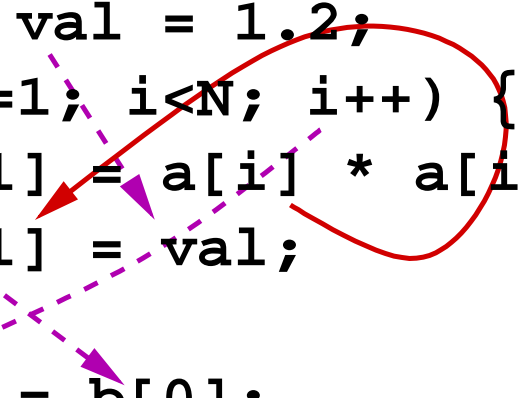

Anti depend. between iterations

True dependece between
loop and environment

Removing dependences

```
double a[N], b[N];
int i;
double val = 1.2;
for (i=1; i<N; i++) {
    b[i-1] = a[i] * a[i];
    a[i-1] = val;
}
a[i-1] = b[0];
```

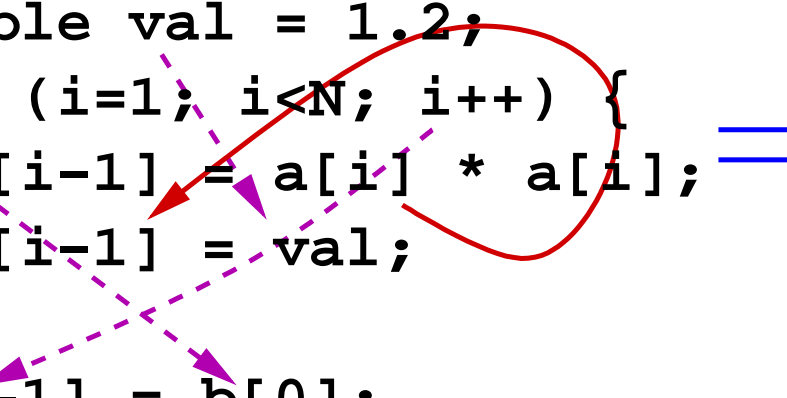

```
double a[N], b[N];
int i;
double val = 1.2;
#pragma omp parallel
{
    #pragma omp for
    for (i=1; i<N; i++)
        b[i-1] = a[i] * a[i];
    #pragma omp for
        lastprivate(i)
    for (i=1; i<N; i++)
        a[i-1] = val;
}
a[i-1] = b[0];
```

Anti depend. between iterations \longrightarrow Loop splitting + barrier

True dependece between loop and environment \longrightarrow lastprivate(i) + barriers



Direction vectors

➔ Is there a dependence within a single iteration or between different iterations?

```
for (i=0; i<N; i++) {  
S1:  a[i] = b[i] + c[i];  
S2:  d[i] = a[i] * 5;  
}
```

```
for (i=1; i<N; i++) {  
S1:  a[i] = b[i] + c[i];  
S2:  d[i] = a[i-1] * 5;  
}
```

```
for (i=1; i<N; i++) {  
    for (j=1; j<N; j++) {  
S1:    a[i][j] = b[i][j] + 2;  
S2:    b[i][j] = a[i-1][j-1] - b[i][j];  
    }  
}
```

2.4.4 Dependence Analysis in Loops



Direction vectors

➔ Is there a dependence within a single iteration or between different iterations?

```
for (i=0; i<N; i++) {  
S1:  a[i] = b[i] + c[i];  
S2:  d[i] = a[i] * 5;  
}
```

S1 $\delta_{(=)}^t$ S2

Direction vector: 
S1 and S2 in same iteration

```
for (i=1; i<N; i++) {  
S1:  a[i] = b[i] + c[i];  
S2:  d[i] = a[i-1] * 5;  
}
```

```
for (i=1; i<N; i++) {  
  for (j=1; j<N; j++) {  
S1:  a[i][j] = b[i][j] + 2;  
S2:  b[i][j] = a[i-1][j-1] - b[i][j];  
  }  
}
```

2.4.4 Dependence Analysis in Loops



Direction vectors

➔ Is there a dependence within a single iteration or between different iterations?

```
for (i=0; i<N; i++) {  
S1:  a[i] = b[i] + c[i];  
S2:  d[i] = a[i] * 5;  
}
```

$S1 \delta_{(=)}^t S2$

Direction vector: 
S1 and S2 in same iteration

```
for (i=1; i<N; i++) {  
S1:  a[i] = b[i] + c[i];  
S2:  d[i] = a[i-1] * 5;  
}
```

S1 in earlier iteration than S2

$S1 \delta_{(<)}^t S2$

Loop carried dependence

```
for (i=1; i<N; i++) {  
  for (j=1; j<N; j++) {  
S1:  a[i][j] = b[i][j] + 2;  
S2:  b[i][j] = a[i-1][j-1] - b[i][j];  
  }  
}
```

2.4.4 Dependence Analysis in Loops



Direction vectors

➔ Is there a dependence within a single iteration or between different iterations?

```
for (i=0; i<N; i++) {  
S1: a[i] = b[i] + c[i];  
S2: d[i] = a[i] * 5;  
}
```

$S1 \delta_{(=)}^t S2$

Direction vector:
S1 and S2 in same iteration

```
for (i=1; i<N; i++) {  
S1: a[i] = b[i] + c[i];  
S2: d[i] = a[i-1] * 5;  
}
```

S1 in earlier iteration than S2

$S1 \delta_{(<)}^t S2$

Loop carried dependence

```
for (i=1; i<N; i++) {  
  for (j=1; j<N; j++) {  
S1: a[i][j] = b[i][j] + 2;  
S2: b[i][j] = a[i-1][j-1] - b[i][j];  
  }  
}
```

$S1 \delta_{(=,=)}^a S2$

2.4.4 Dependence Analysis in Loops



Direction vectors

➔ Is there a dependence within a single iteration or between different iterations?

```
for (i=0; i<N; i++) {  
S1: a[i] = b[i] + c[i];  
S2: d[i] = a[i] * 5;  
}
```

$S1 \delta_{(=)}^t S2$

Direction vector: $S1$ and $S2$ in same iteration

```
for (i=1; i<N; i++) {  
S1: a[i] = b[i] + c[i];  
S2: d[i] = a[i-1] * 5;  
}
```

$S1$ in earlier iteration than $S2$

$S1 \delta_{(<)}^t S2$

Loop carried dependence

```
for (i=1; i<N; i++) {  
  for (j=1; j<N; j++) {  
S1: a[i][j] = b[i][j] + 2;  
S2: b[i][j] = a[i-1][j-1] - b[i][j];  
  }  
}
```

$S1$ in earlier iteration of 'I' and 'J' loop than $S2$

$S1 \delta_{(<, <)}^t S2$

$S1 \delta_{(=, =)}^a S2$

Formal computation of dependences

➔ Basis: Look for integer solutions of systems of (in-)equations

➔ Example:

```
for (i=0; i<10; i++ {  
  for (j=0; j<i; j++) {  
    a[i*10+j] = ...;  
    ... = a[i*20+j-1];  
  }  
}
```

Equation system:

$$0 \leq i_1 < 10$$

$$0 \leq i_2 < 10$$

$$0 \leq j_1 < i_1$$

$$0 \leq j_2 < i_2$$

$$10 i_1 + j_1 = 20 i_2 + j_2 - 1$$

➔ Dependence analysis always is a conservative approximation!

➔ unknown loop bounds, non-linear index expressions, pointers (aliasing), ...



Usage: applicability of code transformations

- ➔ Permissibility of code transformations depends on the (possibly) present data dependences
- ➔ E.g.: parallel execution of a loop is possible, if
 - ➔ this loop does not carry any data dependence
 - ➔ i.e., all direction vectors have the form $(\dots, =, \dots)$ or $(\dots, \neq, \dots, *, \dots)$ [red: considered loop]
- ➔ E.g.: *loop interchange* is permitted, if
 - ➔ loops are perfectly nested
 - ➔ loop bounds of the inner loop are independent of the outer loop
 - ➔ no dependences with direction vector $(\dots, <, >, \dots)$

2.4.4 Dependence Analysis in Loops ...



Example: block algorithm for matrix multiplication

```
DO I = 1,N
  DO J = 1,N
    DO K = 1,N
      A(I,J)=A(I,J)+B(I,K)*C(K,J)
```

*Strip
mining*

```
DO I = 1,N
  ↓
  DO IT = 1,N,IS
  DO I = IT, MIN(N,IT+IS-1)
```

```
DO IT = 1,N,IS
DO I = IT, MIN(N,IT+IS-1)
  DO JT = 1,N,JS
  DO J = JT, MIN(N,JT+JS-1)
    DO KT = 1,N,KS
    DO K = KT, MIN(N,KT+KS-1)
      A(I,J)=A(I,J)+B(I,K)*C(K,J)
```

```
DO IT = 1,N,IS
DO JT = 1,N,JS
DO KT = 1,N,KS
  DO I = IT, MIN(N,IT+IS-1)
  DO J = JT, MIN(N,JT+JS-1)
  DO K = KT, MIN(N,KT+KS-1)
    A(I,J)=A(I,J)+B(I,K)*C(K,J)
```

*Loop
interchange*



Numerical solution of the equations for thermal conduction

- ➔ Concrete problem: thin metal plate
 - ➔ given: temperature profile of the boundary
 - ➔ gesucht: temperature profile of the interior
- ➔ Approach:
 - ➔ discretization: consider the temperature only at equidistant grid points
 - ➔ 2D array of temperature values
 - ➔ iterative solution: compute ever more exact approximations
 - ➔ new approximations for the temperature of a grid point: mean value of the temperatures of the neighboring points

2.5 Example: The Jacobi and Gauss/Seidel Methods ...



Numerical solution of the equations for thermal conduction ...

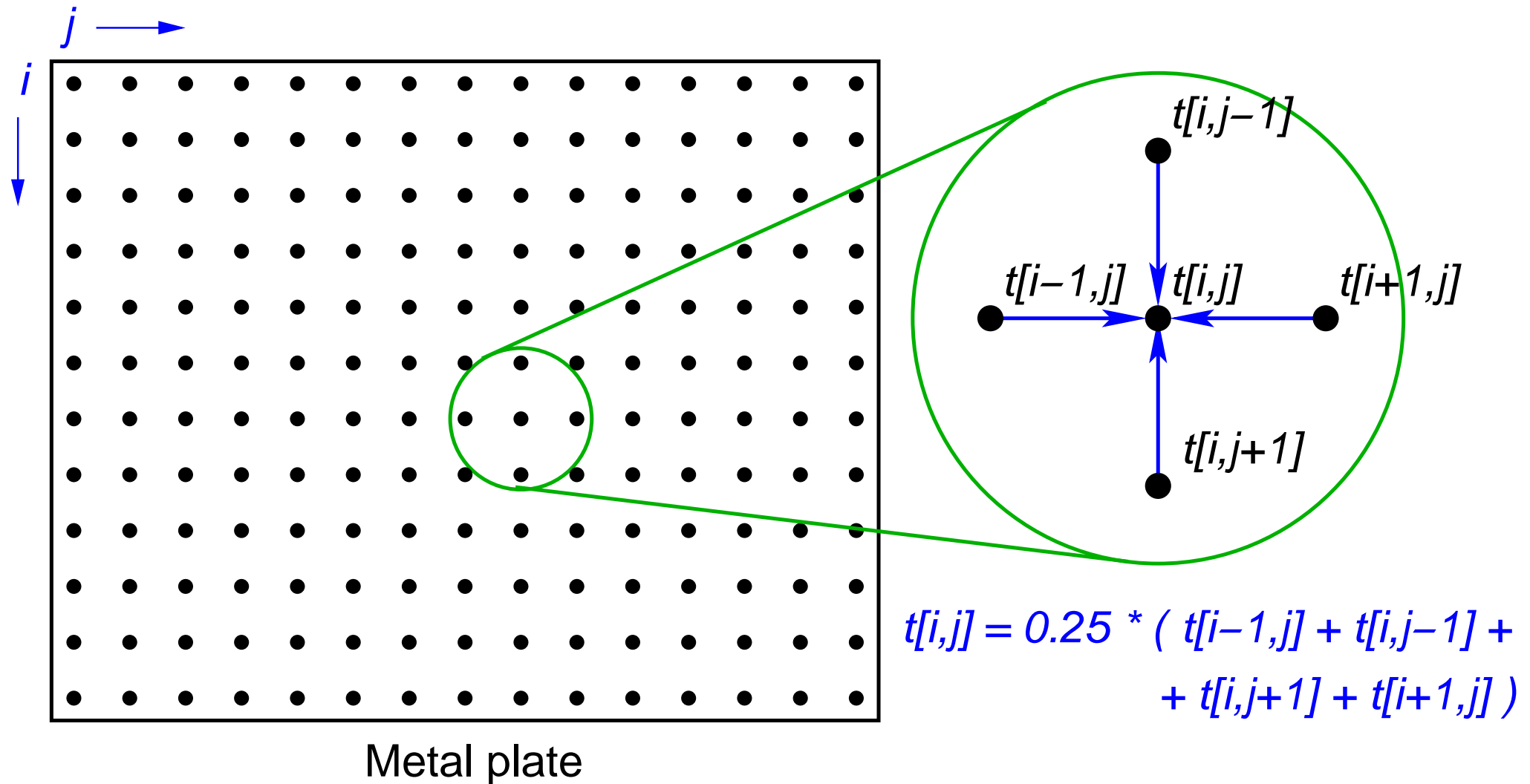



Variants of the method

➔ Jacobi iteration

- ➔ to compute the new values, only the values of the last iteration are used
- ➔ computation uses two matrices

➔ Gauss/Seidel relaxation

- ➔ to compute the new values, also some values of the current iteration are used:
 - ➔ $t[i - 1, j]$ and $t[i, j - 1]$
- ➔ computation uses only one matrix
- ➔ usually faster convergence as compared to Jacobi



Variants of the method ...

Jacobi

```
do {
  for(i=1;i<N-1;i++) {
    for(j=1;j<N-1;j++) {
      b[i][j] = 0.25 *
        (a[i-1][j] + ...);
    }
  }
  for(i=1;i<N-1;i++) {
    for(j=1;j<N-1;j++) {
      a[i][j] = b[i][j];
    }
  }
} until (converged);
```

Gauss/Seidel

```
do {
  for(i=1;i<N-1;i++) {
    for(j=1;j<N-1;j++) {
      a[i][j] = 0.25 *
        (a[i-1][j] + ...);
    }
  }
} until (converged);
```



Dependencies in Jacobi and Gauss/Seidel

- ➔ Jacobi: only between the two i loops
- ➔ Gauss/Seidel: iterations of the i, j loop depend on each other

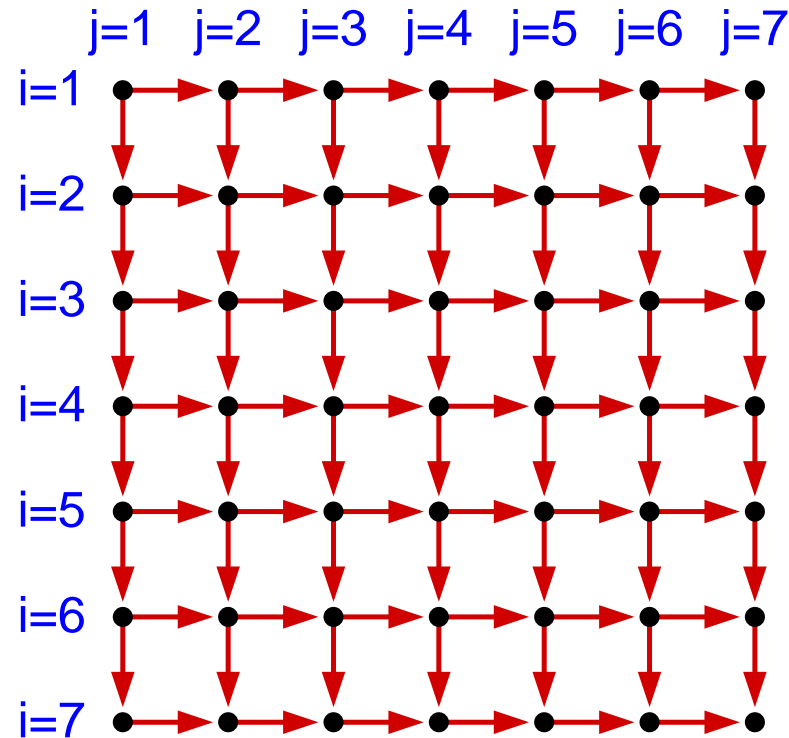

The figure shows the loop iterations, not the matrix elements!



Dependencies in Jacobi and Gauss/Seidel

- ➔ Jacobi: only between the two i loops
- ➔ Gauss/Seidel: iterations of the i, j loop depend on each other

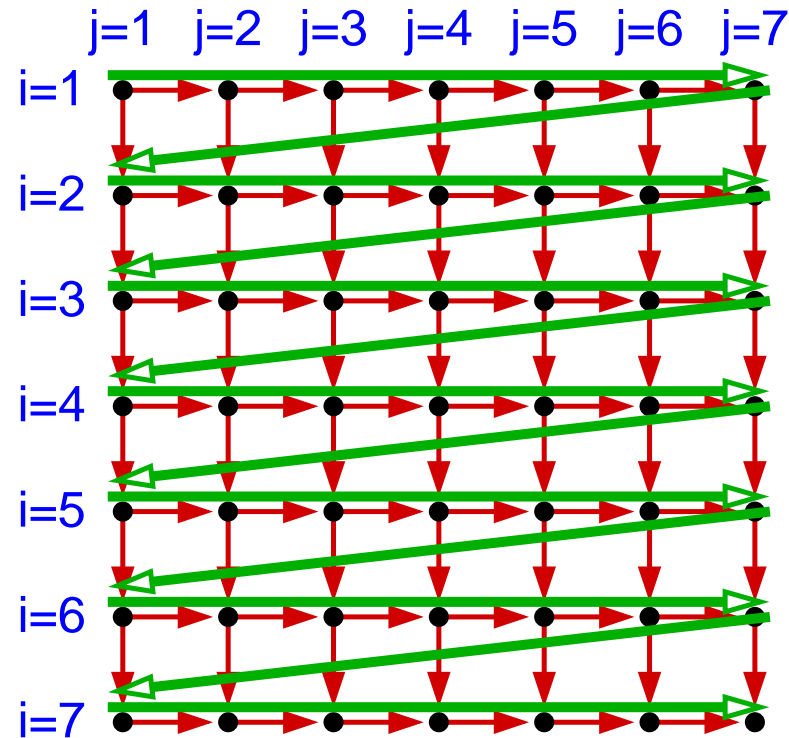

Sequential
execution
order

The figure
shows the loop
iterations, not
the matrix
elements!



Parallelisation of the Gauss/Seidel method

- ➔ Restructure the i, j loop, such that the iteration space is traversed diagonally
- ➔ no dependences between the iterations of the inner loop
- ➔ problem: varying degree of parallelism

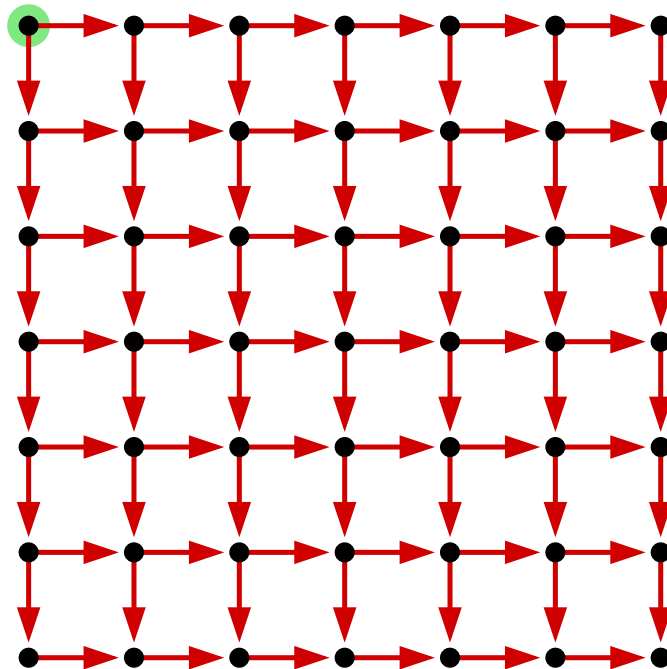



Parallelisation of the Gauss/Seidel method

- ➔ Restructure the i, j loop, such that the iteration space is traversed diagonally
- ➔ no dependences between the iterations of the inner loop
- ➔ problem: varying degree of parallelism

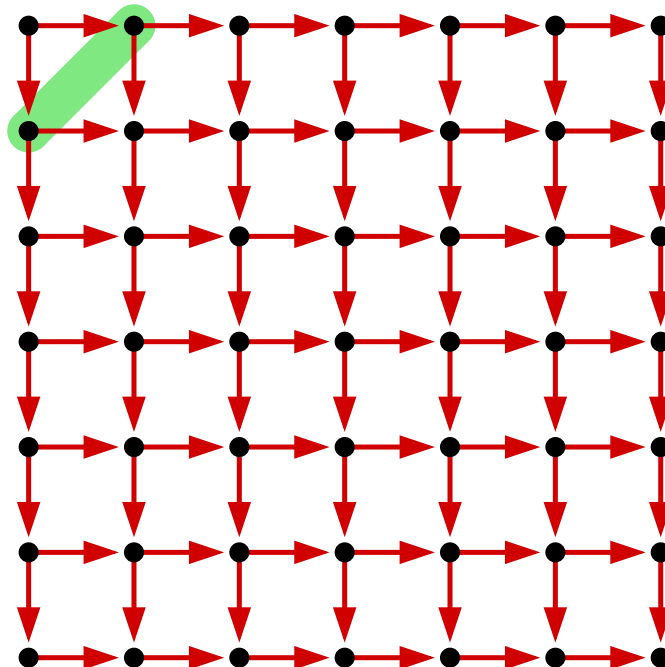



Parallelisation of the Gauss/Seidel method

- ➔ Restructure the i, j loop, such that the iteration space is traversed diagonally
- ➔ no dependences between the iterations of the inner loop
- ➔ problem: varying degree of parallelism

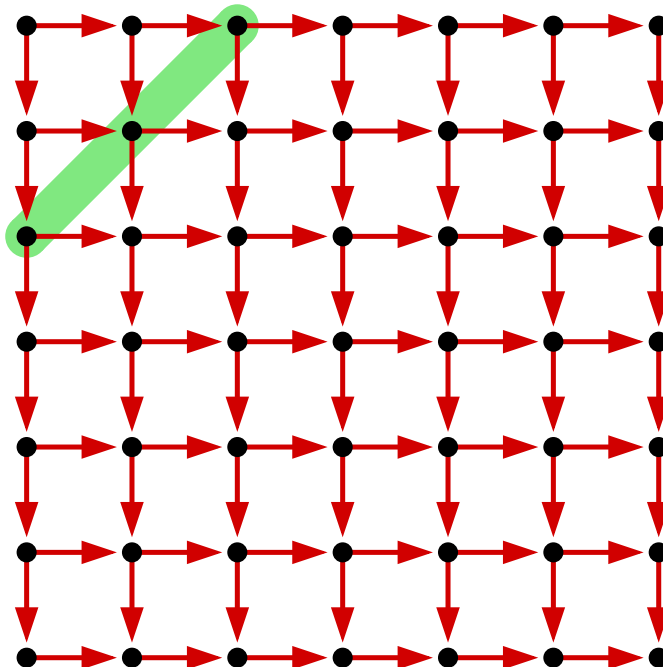



Parallelisation of the Gauss/Seidel method

- ➔ Restructure the i, j loop, such that the iteration space is traversed diagonally
- ➔ no dependences between the iterations of the inner loop
- ➔ problem: varying degree of parallelism

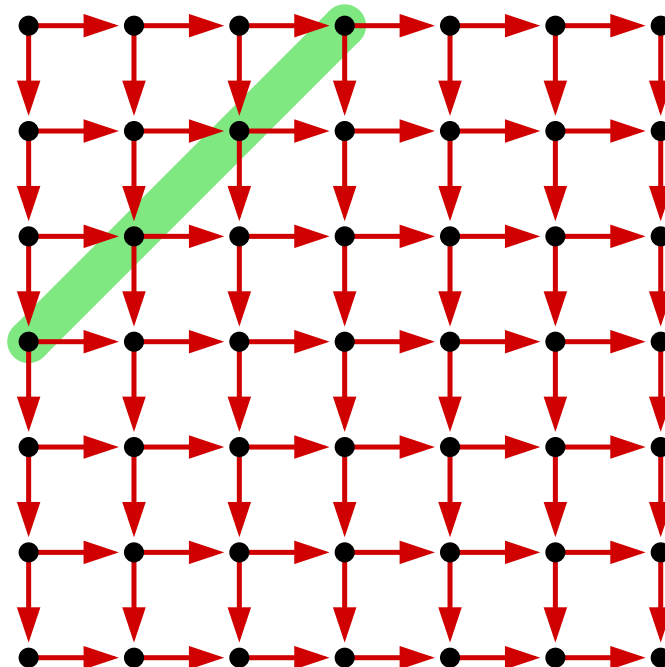



Parallelisation of the Gauss/Seidel method

- ➔ Restructure the i, j loop, such that the iteration space is traversed diagonally
- ➔ no dependences between the iterations of the inner loop
- ➔ problem: varying degree of parallelism

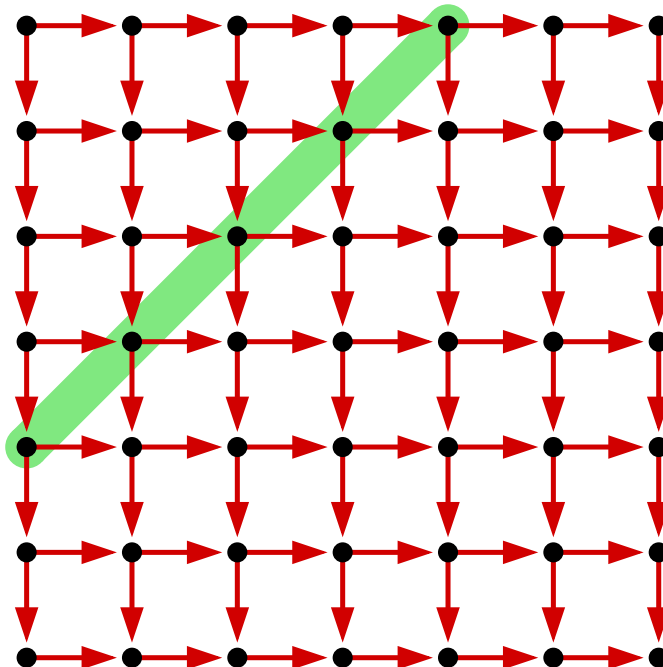



Parallelisation of the Gauss/Seidel method

- ➔ Restructure the i, j loop, such that the iteration space is traversed diagonally
- ➔ no dependences between the iterations of the inner loop
- ➔ problem: varying degree of parallelism

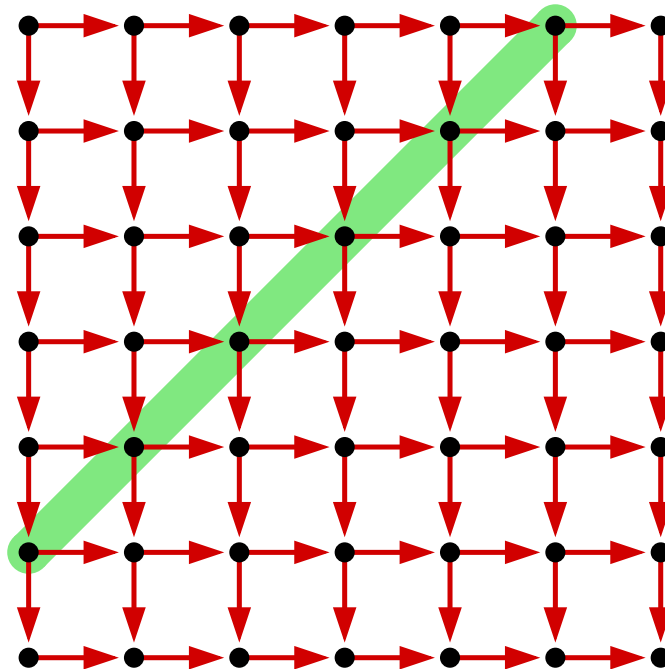



Parallelisation of the Gauss/Seidel method

- ➔ Restructure the i, j loop, such that the iteration space is traversed diagonally
- ➔ no dependences between the iterations of the inner loop
- ➔ problem: varying degree of parallelism

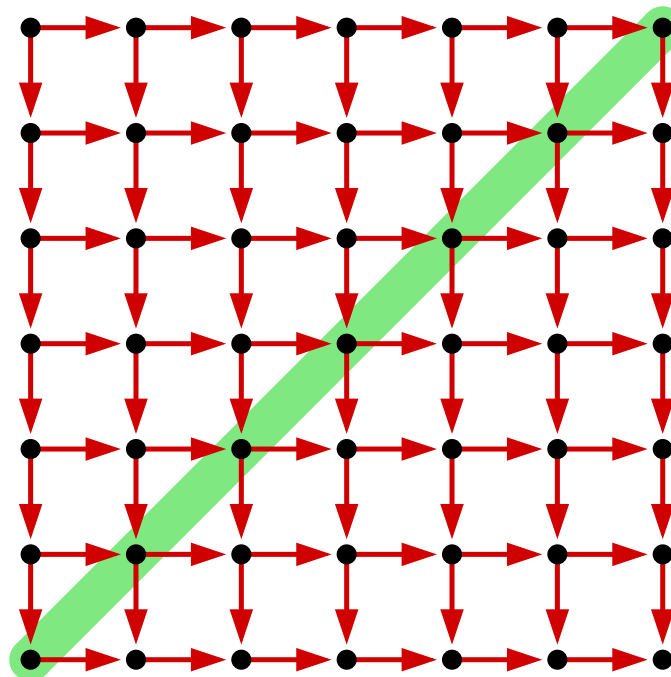



Parallelisation of the Gauss/Seidel method

- ➔ Restructure the i, j loop, such that the iteration space is traversed diagonally
- ➔ no dependences between the iterations of the inner loop
- ➔ problem: varying degree of parallelism

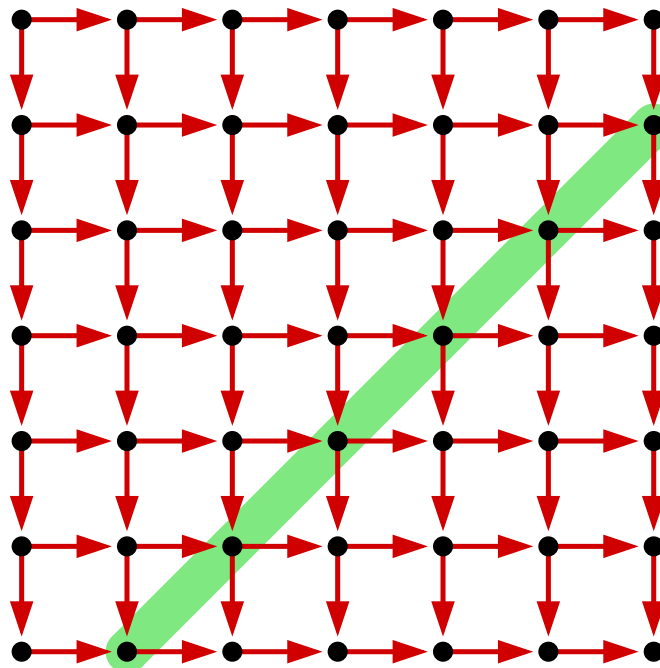



Parallelisation of the Gauss/Seidel method

- ➔ Restructure the i, j loop, such that the iteration space is traversed diagonally
- ➔ no dependences between the iterations of the inner loop
- ➔ problem: varying degree of parallelism

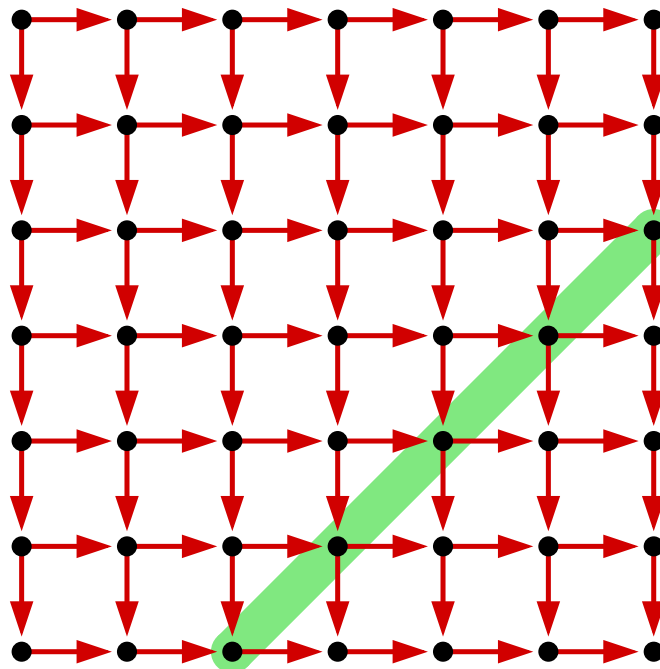



Parallelisation of the Gauss/Seidel method

- ➔ Restructure the i, j loop, such that the iteration space is traversed diagonally
- ➔ no dependences between the iterations of the inner loop
- ➔ problem: varying degree of parallelism

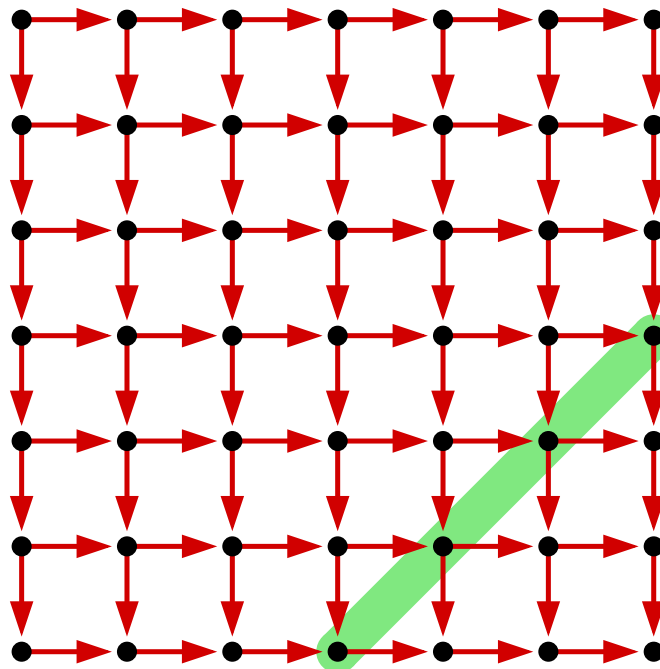



Parallelisation of the Gauss/Seidel method

- ➔ Restructure the i, j loop, such that the iteration space is traversed diagonally
- ➔ no dependences between the iterations of the inner loop
- ➔ problem: varying degree of parallelism

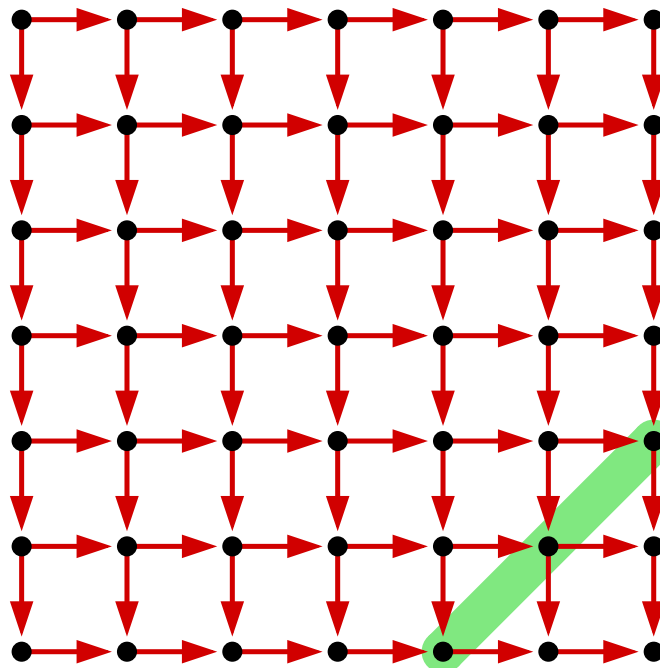



Parallelisation of the Gauss/Seidel method

- ➔ Restructure the i, j loop, such that the iteration space is traversed diagonally
- ➔ no dependences between the iterations of the inner loop
- ➔ problem: varying degree of parallelism

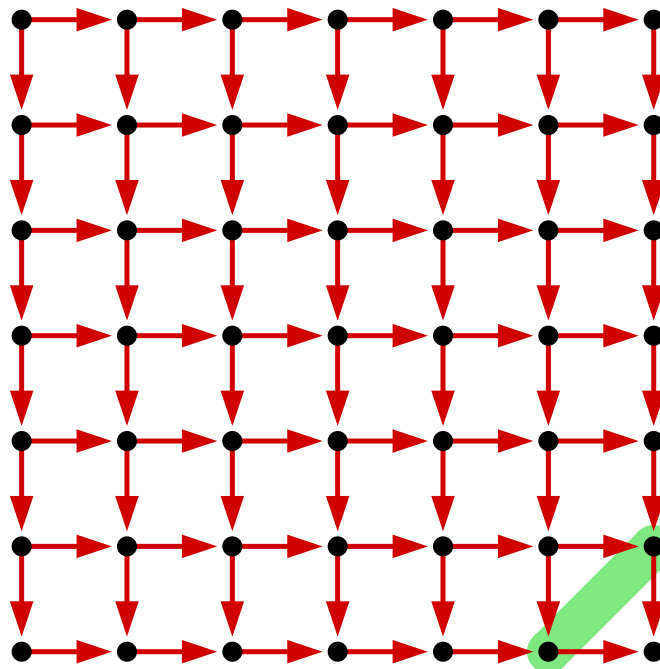



Parallelisation of the Gauss/Seidel method

- ➔ Restructure the i, j loop, such that the iteration space is traversed diagonally
- ➔ no dependences between the iterations of the inner loop
- ➔ problem: varying degree of parallelism

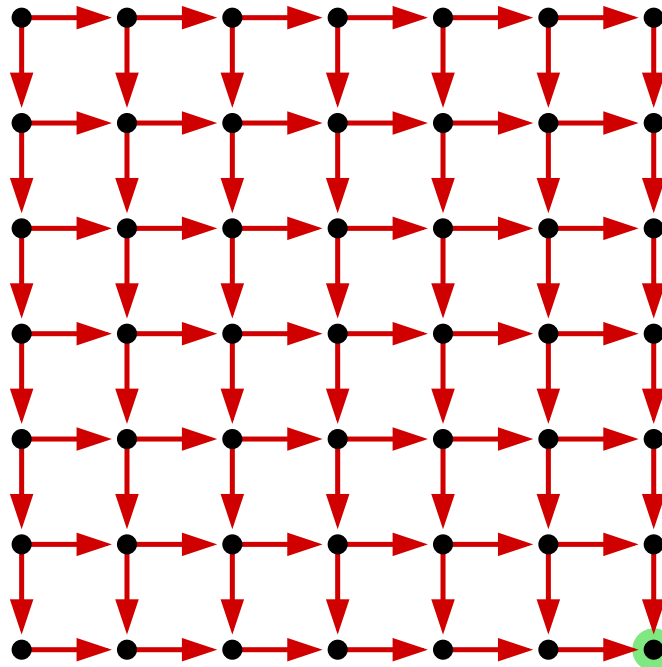



Loop restructuring in the Gauss/Seidel method

➔ Row-wise traversal of the matrix:

```
for (i=1; i<n-1; i++) {  
    for (j=1; j<n-1; j++) {  
        a[i][j] = ...;  
    }  
}
```

➔ Diagonal traversal of the matrix (👉 02/diagonal.cpp):

```
for (ij=1; ij<2*n-4; ij++) {  
    int ja = (ij <= n-2) ? 1 : ij-(n-3);  
    int je = (ij <= n-2) ? ij : n-2;  
    for (j=ja; j<=je; j++) {  
        i = ij-j+1;  
        a[i][j] = ...;  
    }  
}
```



Alternative parallelization of the Gauss/Seidel method

- ➔ Requirement: number of iterations is known in advance
 - ➔ (or: we are allowed to execute a few more iterations after convergence)
- ➔ Then we can use a pipeline-style parallelization

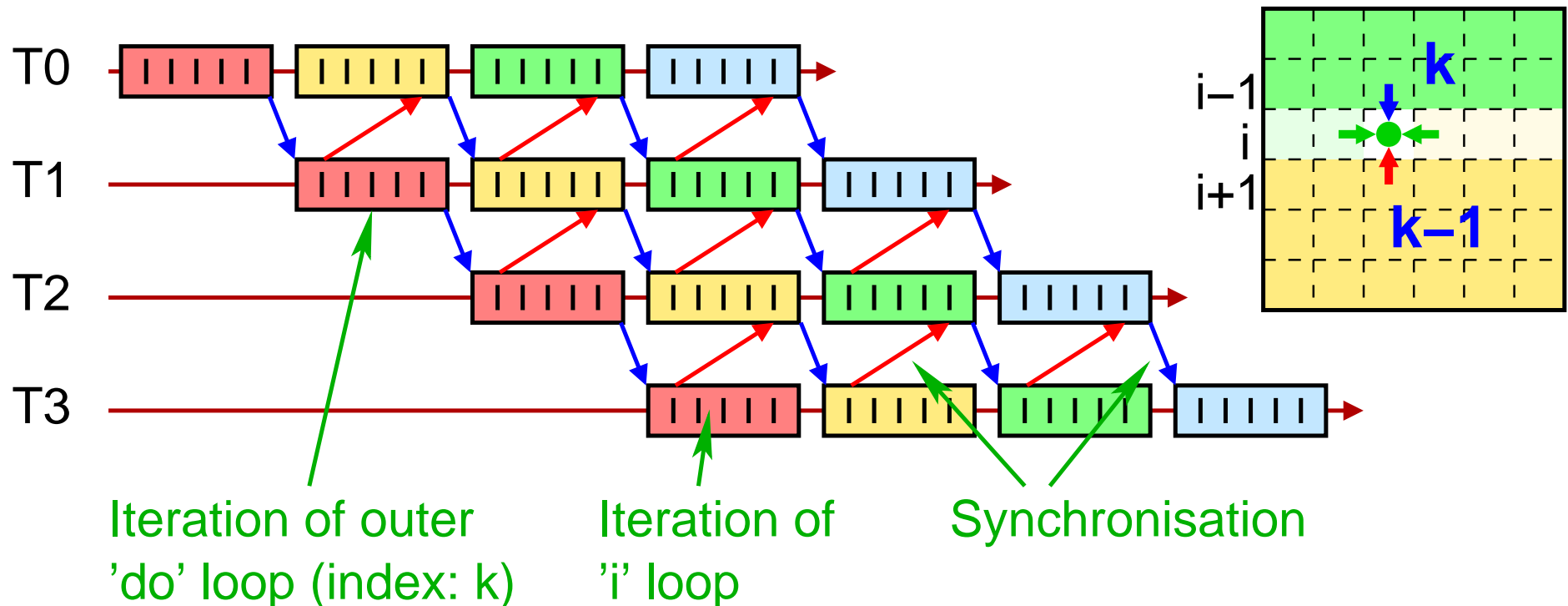

2.5 Example: The Jacobi and Gauss/Seidel Methods ...



Results

➔ Speedup using g++ -O on bslab10 in H-A 4111 (eps=0.001):

Thr.	Jacobi					Gauss/Seidel (diagonal)				
	500	700	1000	2000	4000	500	700	1000	2000	4000
1	0.9	0.9	0.9	0.9	0.9	1.8	2.0	1.6	1.6	1.3
2	1.8	1.5	1.4	1.4	1.4	3.5	3.7	2.1	2.6	2.6
3	2.6	2.0	1.6	1.6	1.6	4.0	4.4	2.5	2.7	3.1
4	3.3	2.3	1.7	1.6	1.6	4.1	4.8	3.0	3.0	3.5

➔ Slight performance loss due to compilation with OpenMP

➔ Diagonal traversal in Gauss/Seidel improves performance

➔ High speedup with Gauss/Seidel at a matrix size of 700

➔ data size: ~ 8MB, cache size: 4MB per dual core CPU

2.5 Example: The Jacobi and Gauss/Seidel Methods ...



Speedup on the HorUS cluster: Jacobi

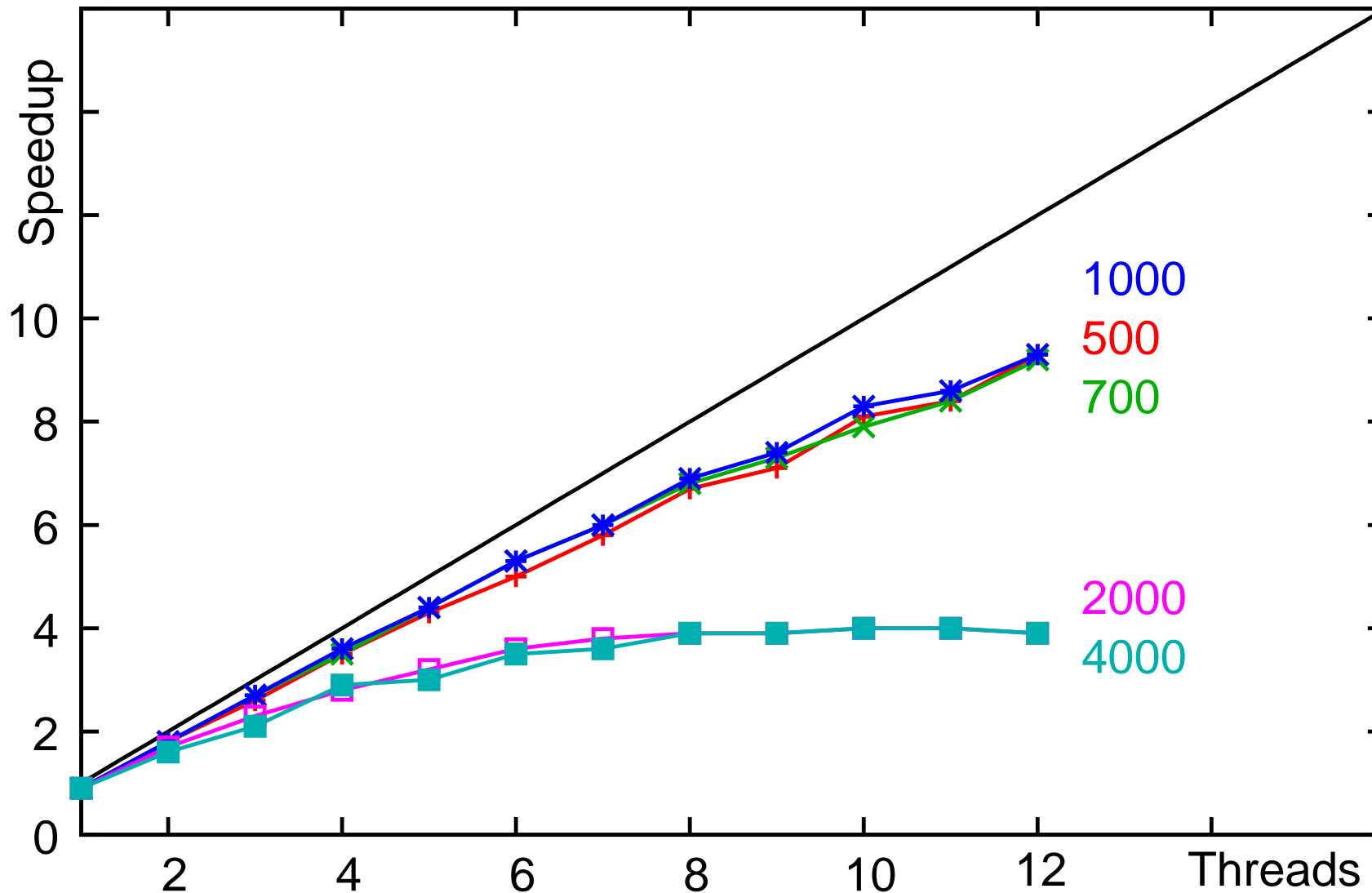

2.5 Example: The Jacobi and Gauss/Seidel Methods ...



Speedup on the HorUS cluster: Gauss/Seidel (diagonal)

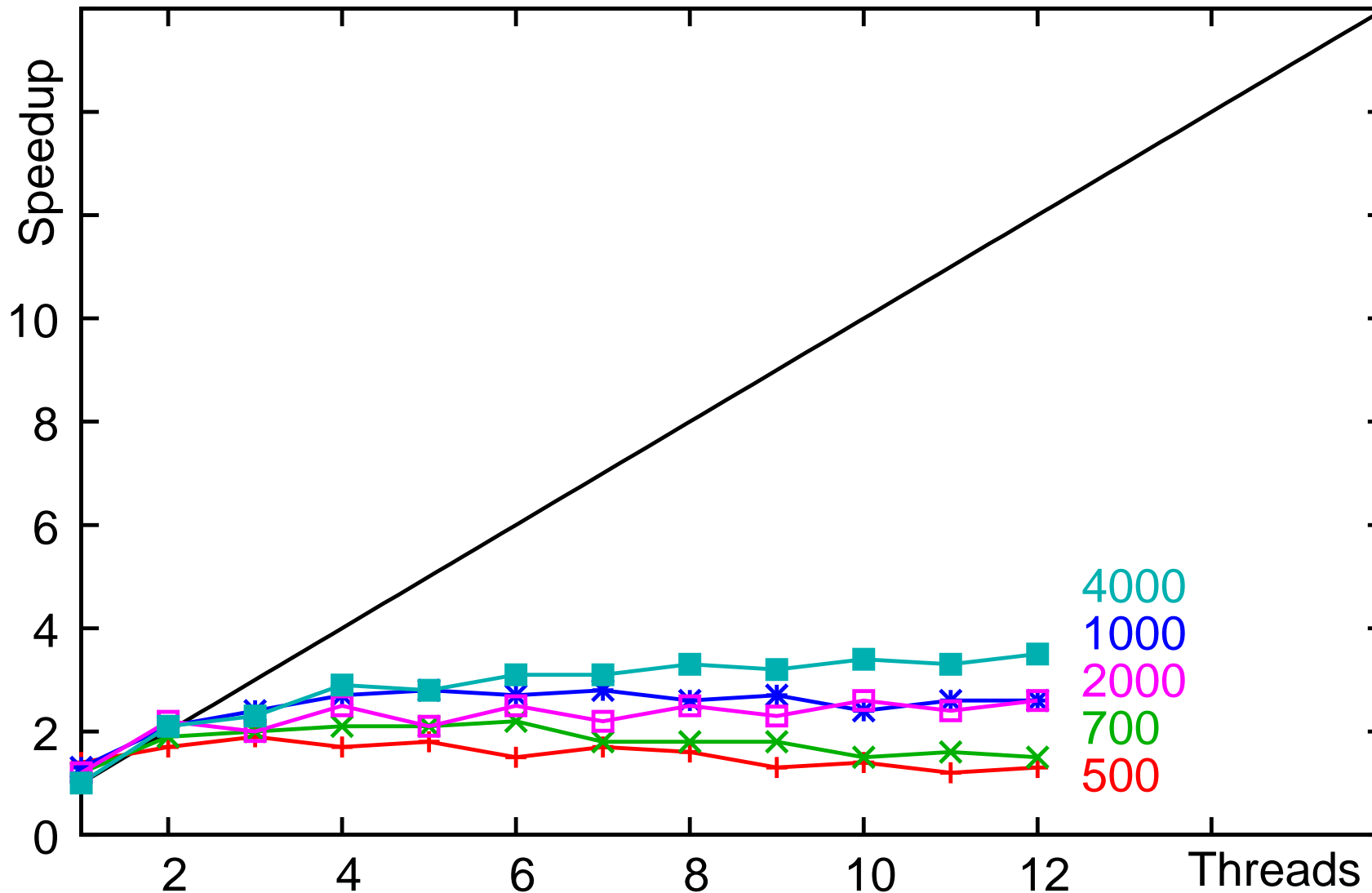

2.5 Example: The Jacobi and Gauss/Seidel Methods ...



Speedup on the HorUS cluster: Gauss/Seidel (pipeline)

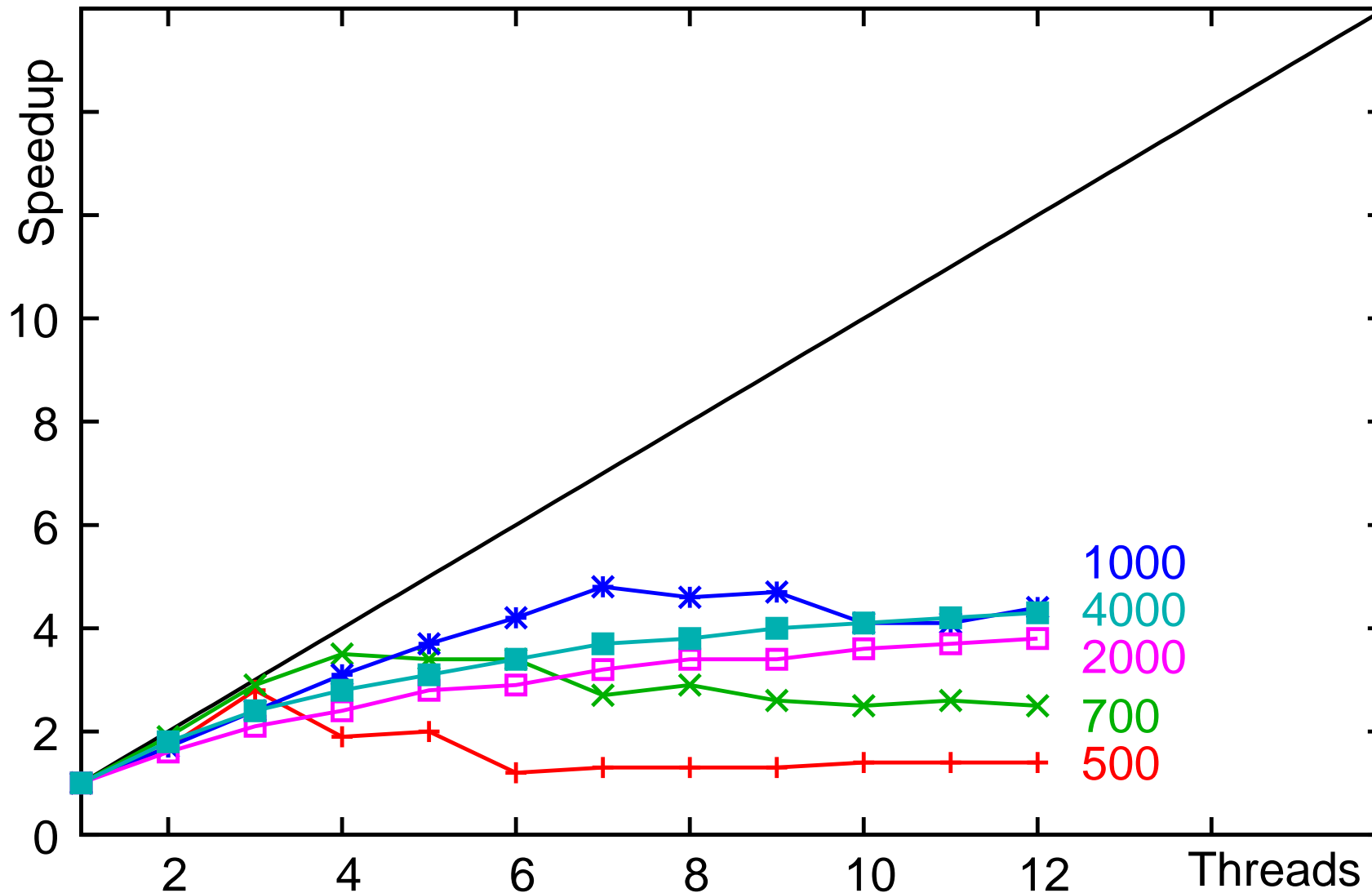

2.6 OpenMP Synchronization



➔ When using OpenMP, the programmer bears full responsibility for the correct synchronization of the threads!

➔ A motivating example:

```
int i, j = 0;
```

```
#pragma omp parallel for private(i)
```

```
for (i=1; i<N; i++) {
```

```
    if (a[i] > a[j])
```

```
        j = i;
```

```
}
```

➔ when the OpenMP directive is added, does this code fragment still compute the index of the largest element in j?

➔ the memory accesses of the threads can be interleaved in an arbitrary order \Rightarrow nondeterministic errors!



Synchronization in OpenMP

- ➔ Higher-level, easy to use constructs
- ➔ Implementation using directives:
 - ➔ `barrier`: barrier
 - ➔ `single` and `master`: execution by a single thread
 - ➔ `critical`: critical section
 - ➔ `atomic`: atomic operations
 - ➔ `ordered`: execution in program order
 - ➔ `taskwait` and `taskgroup`: wait for tasks (👉 **2.7.2**)
 - ➔ `flush`: make the memory consistent
 - ➔ memory barrier (👉 **1.4.2**)
 - ➔ implicitly executed with the other synchronization directives

Parallel Processing

WS 2017/18

27.11.2017

Roland Wismüller
Universität Siegen
roland.wismueller@uni-siegen.de
Tel.: 0271/740-4050, Büro: H-B 8404

Stand: January 15, 2018



Barrier

```
#pragma omp barrier
```

- ➔ Synchronizes all threads
 - ➔ each thread waits, until all other threads have reached the barrier
- ➔ Implicit barrier at the end of `for`, `sections`, and `single` directives
 - ➔ can be removed by specifying the option `nowait`

2.6 OpenMP Synchronization ...



Barrier: example (👉 02/barrier.cpp)

```
#include <stdio.h>
#include <stdlib.h>
#include <math.h>

#define N 10000

float a[N][N];

main() {
    int i, j;

    #pragma omp parallel
    {
        int thread = omp_get_thread_num();
        cout << "Thread " << thread << ": start loop 1\n";
    #pragma omp for private(i,j) // add nowait, as the case may be
        for (i=0; i<N; i++) {
```

2.6 OpenMP Synchronization ...



```
    for (j=0; j<i; j++) {
        a[i][j] = sqrt(i) * sin(j*j);
    }
}

cout << "Thread " << thread << ": start loop 2\n";
#pragma omp for private(i,j)
for (i=0; i<N; i++) {
    for (j=i; j<N; j++) {
        a[i][j] = sqrt(i) * cos(j*j);
    }
}
cout << "Thread " << thread << ": end loop 2\n";
}
}
```



Barriere: example ...

- ➔ The first loop processes the upper triangle of the matrix a , the second loop processes the lower triangle
 - ➔ load imbalance between the threads
 - ➔ barrier at the end of the loop results in waiting time
- ➔ But: the second loop does not depend on the first one
 - ➔ i.e., the computation can be started, before the first loop has been executed completely
 - ➔ the barrier at the end of the first loop can be removed
 - ➔ option `nowait`
 - ➔ run time with 2 threads only 4.8 s instead of 7.2 s

Barriere: example ...

➔ Executions of the program:

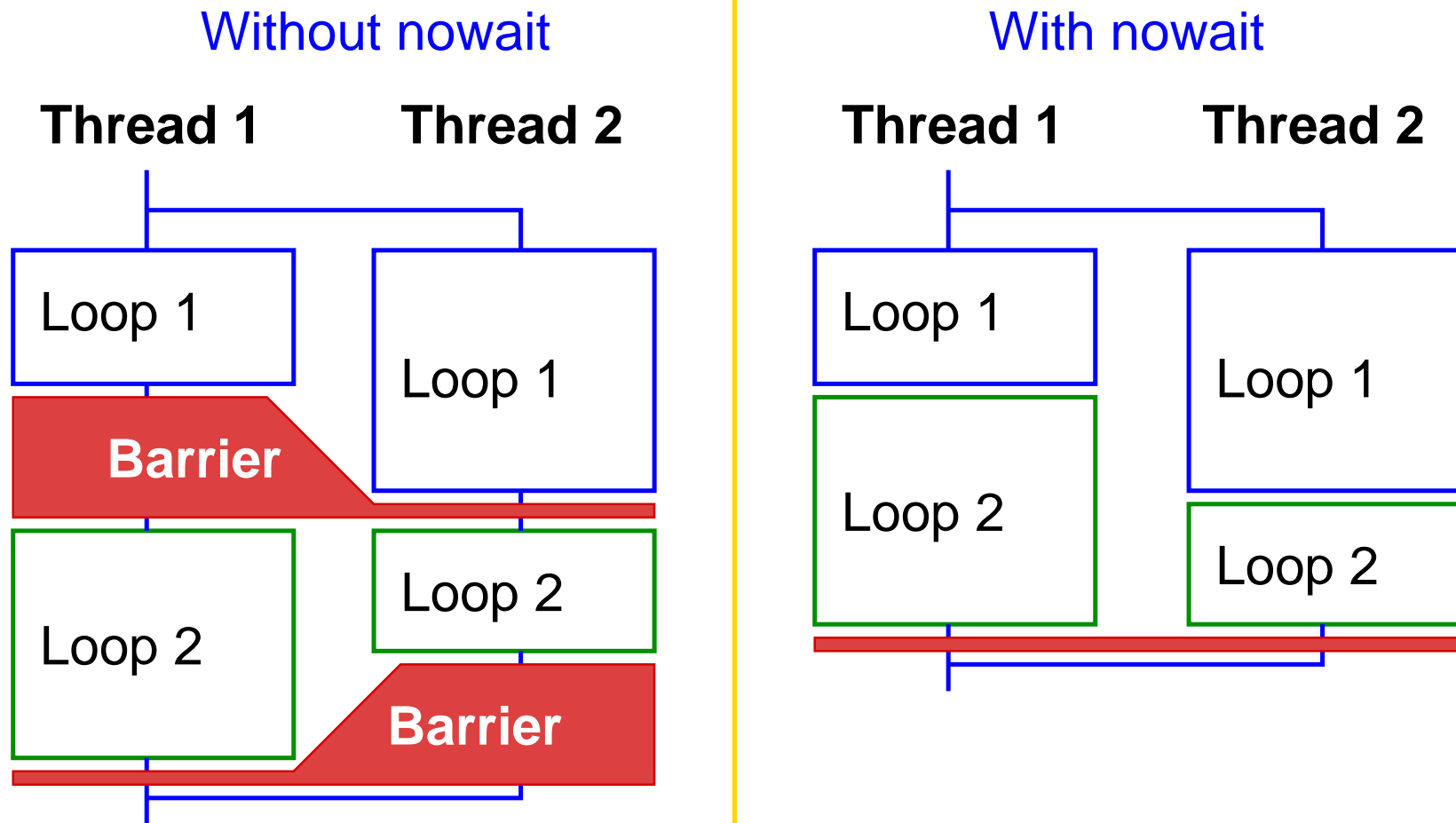

Execution using a single thread

```
#pragma omp single  
Statement / Block
```

```
#pragma omp master  
Statement / Block
```

- ➔ Block is only executed by a single thread
- ➔ No synchronization at the beginning of the directive
- ➔ `single` directive:
 - ➔ first arriving thread will execute the block
 - ➔ barrier synchronization at the end (unless: `nowait`)
- ➔ `master` directive:
 - ➔ master thread will execute the block
 - ➔ no synchronization at the end



Critical sections

```
#pragma omp critical [(<name>)]  
Statement / Block
```

- ➔ Statement / block is executed under mutual exclusion
- ➔ In order to distinguish different critical sections, they can be assigned a name



Atomic operations

```
#pragma omp atomic [read|write|update|capture] [seq_cst]  
Statement / Block
```

- ➔ Statement or block (only with `capture`) will be executed atomically
 - ➔ usually by compiling it into special machine instructions
- ➔ Considerably more efficient than critical section
- ➔ The option defines the type of the atomic operation:
 - ➔ `read / write`: atomic read / write
 - ➔ `update` (default): atomic update of a variable
 - ➔ `capture`: atomic update of a variable, while storing the old or the new value, respectively
- ➔ Option `seq_cst`: enforce memory consistency (`flush`)

Atomic operations: examples

➔ Atomic adding:

```
#pragma omp atomic update  
x += a[i] * a[j];
```

➔ the right hand side will **not** be evaluated atomically!

➔ Atomic *fetch-and-add*:

```
#pragma omp atomic capture  
{ old = counter; counter += size; }
```

➔ Instead of +, all other binary operators are possible, too

➔ Currently, an atomic *compare-and-swap* can not (yet) be implemented with OpenMP

➔ use builtin functions of the compiler, if necessary

Execution in program order

```
#pragma omp for ordered
for(...) {
    ...
    #pragma omp ordered
    Statement / Block
    ...
}
```

- ➔ The `ordered` directive is only allowed in the dynamic extent of a `for` directive with option `ordered`
 - ➔ recommendation: use option `schedule(static,1)`
- ➔ The threads will execute the instances of the statement / block exactly in the same order as in the sequential program

2.6 OpenMP Synchronization ...



Execution with ordered

```
#pragma omp for ordered
for(i=0; i<N; i++) {
    S1;
    #pragma omp ordered
        S2;
    S3;
}
```

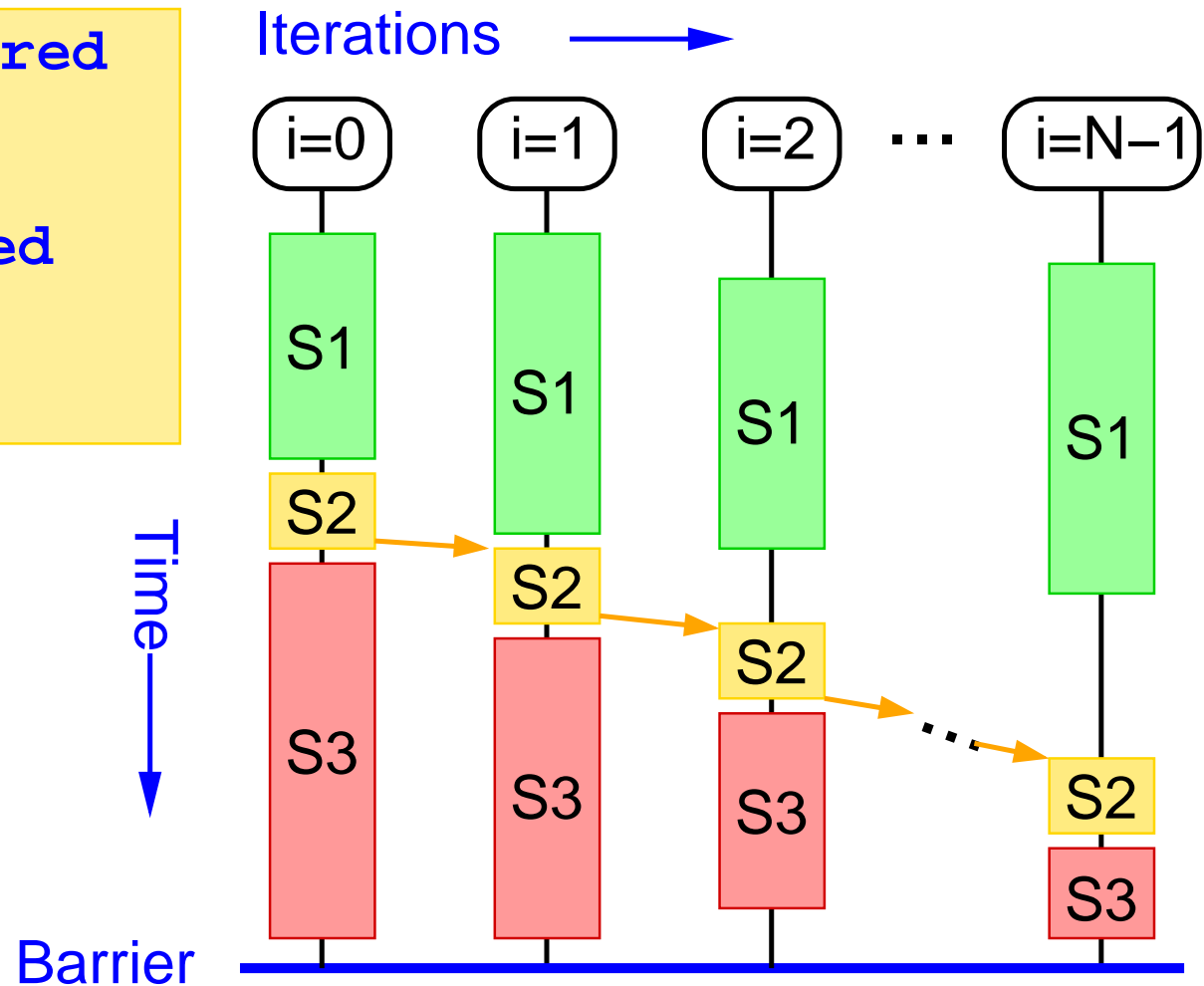

Reduction operations

- ➔ Often loops aggregate values, e.g.:

```
int a[N];
int i, sum = 0;
#pragma omp parallel for reduction(+: sum)
for (i=0; i<N; i++){
    sum += a[i];
}
printf("sum=%d\n", sum);
```

At the end of the loop, 'sum'
contains the sum of all elements

- ➔ reduction saves us a critical section
 - ➔ each thread first computes its partial sum in a private variable
 - ➔ after the loop ends, the total sum is computed
- ➔ Instead of + is also possible to use other operators:
 - * & | ^ && || min max
 - ➔ in addition, user defined operators are possible

Example: reduction without reduction option

```
int a[N];
int i, sum = 0;
int lsum = 0; // local partial sum

#pragma omp parallel firstprivate(lsum) private(i)
{
  #pragma omp for nowait ← No barrier at the end
    for (i=0; i<N; i++) {
      lsum += a[i];
    }
  #pragma omp atomic
    sum += lsum; ← Add local partial sum
}
printf("sum=%d\n", sum);
```

'lsum' is initialized with 0

No barrier at the end of the loop

Add local partial sum to the global sum

Example: reduction without reduction option

```
int a[N];
int i, sum = 0;

#pragma omp parallel private(i)
{
    int lsum = 0; // local partial sum
    # pragma omp for nowait ← No barrier at the end
    for (i=0; i<N; i++) {      of the loop
        lsum += a[i];
    }
    # pragma omp atomic
    sum += lsum; ← Add local partial sum
}                               to the global sum
printf("sum=%d\n", sum);
```

2.7 Task Parallelism with OpenMP



2.7.1 The `sections` Directive: Parallel Code Regions

```
#pragma omp sections [<clause_list>]
{
  #pragma omp section
  Statement / Block
  #pragma omp section
  Statement / Block
  ...
}
```

- ➔ Each section will be executed exactly once by one (arbitrary) thread
- ➔ At the end of the `sections` directive, a barrier synchronization is performed
 - ➔ unless the option `nowait` is specified



Example: independent code parts

```
double a[N], b[N];
int i;
#pragma omp parallel sections private(i)
{
    #pragma omp section
    for (i=0; i<N; i++)
        a[i] = 100;
    #pragma omp section
    for (i=0; i<N; i++)
        b[i] = 200;
}
```

Important!!

- ➔ The two loops can be executed concurrently to each other
- ➔ Task partitioning

2.7.1 The sections directive ...



Example: influence of `nowait` (👉 02/sections.cpp)

```
main() {
    int p;
    #pragma omp parallel private(p)
    {
        int thread = omp_get_thread_num();
        #pragma omp sections // ggf. nowait
        {
            #pragma omp section
            {
                cout << "Thread " << thread << ", Section 1 start\n";
                usleep(200000);
                cout << "Thread " << thread << ", Section 1 end\n";
                p = 1;
            }
            #pragma omp section
            {
                cout << "Thread " << thread << ", Section 2 start\n";
            }
        }
    }
}
```

2.7.1 The sections directive ...



```
        usleep(1000000);
        cout << "Thread " << thread << ", Section 2 end\n";
        p = 2;
    }
} // End omp sections
#pragma omp sections
{
#pragma omp section
{
    cout << "Thread " << thread << ", Section 3 start, p = "
        << p << "\n";
    usleep(200000);
    cout << "Thread " << thread << ", Section 3 end\n";
    p = 3;
}
#pragma omp section
{
    cout << "Thread " << thread << ", Section 4 start, p = "
```

2.7.1 The sections directive ...



```
        << p << "\n";
    usleep(200000);
    cout << "Thread " << thread << ", Section 4 end\n";
    p = 4;
}
#pragma omp section
{
    cout << "Thread " << thread << ", Section 5 start, p = "
        << p << "\n";
    usleep(200000);
    cout << "Thread " << thread << ", Section 5 end\n";
    p = 5;
}
} // End omp sections
} // End omp parallel
}
```

2.7.1 The sections directive ...



Example: influence of `nowait` ...

➔ Executions of the program **without** `nowait` option:

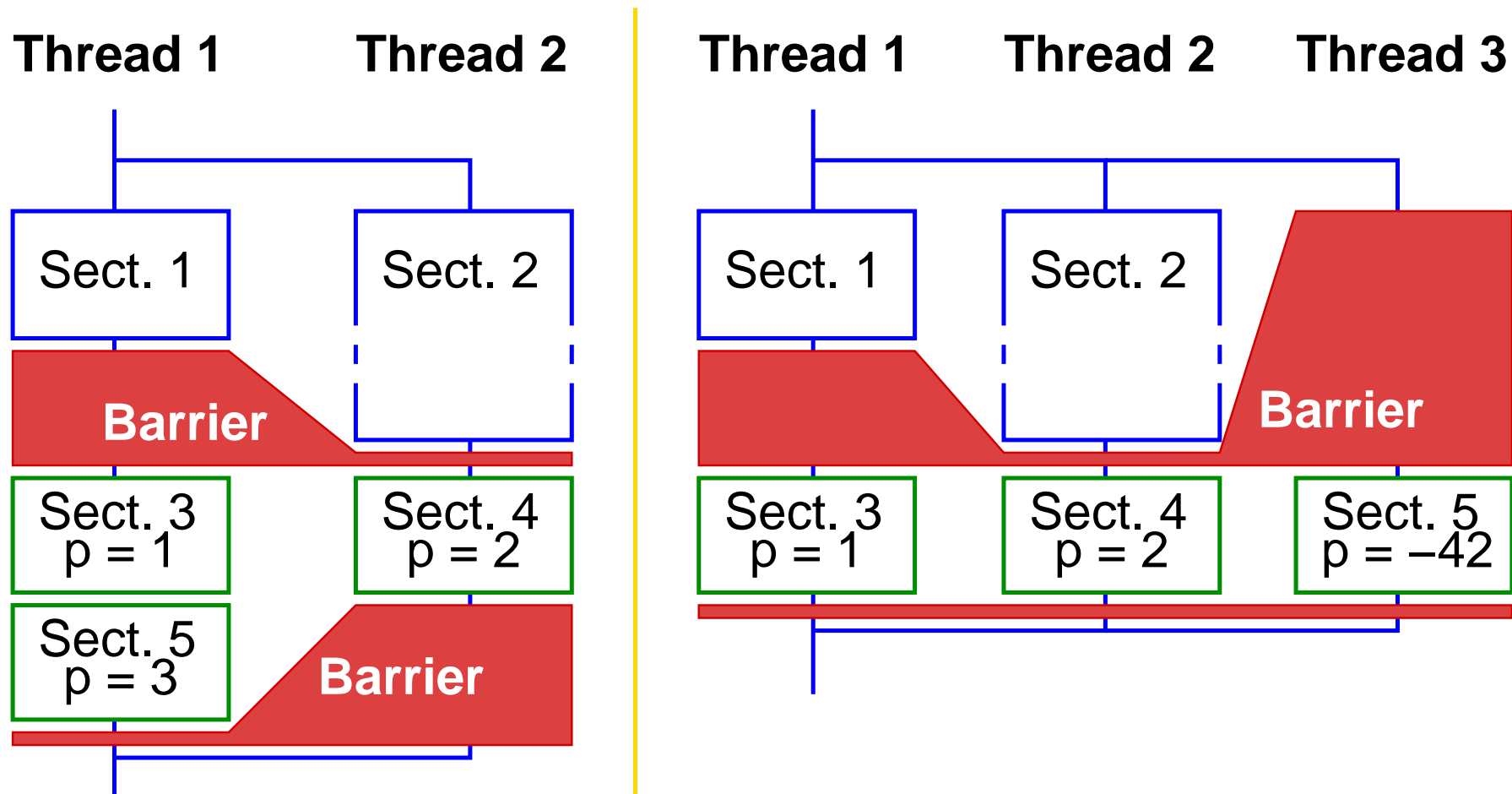

2.7.1 The sections directive ...



Example: influence of `nowait` ...

➔ Executions of the program **with** `nowait` option:

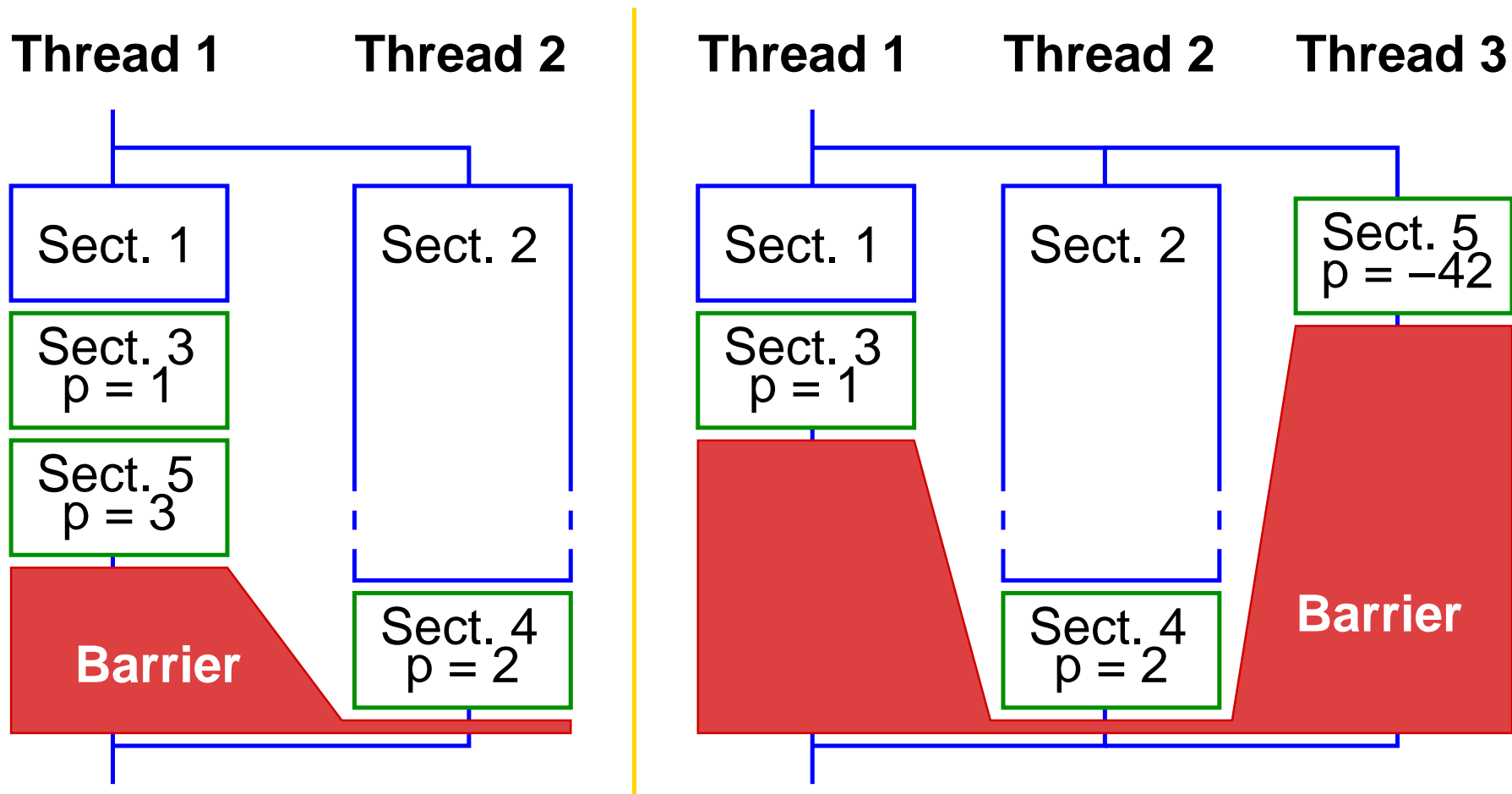



2.7.2 The `task` Directive: Explicit Tasks

```
#pragma omp task[<clause_list>]  
Statement/Block
```

- ➔ Creates an explicit task from the statement / the block
- ➔ Tasks will be executed by the available threads (*work pool* model)
- ➔ Options `private`, `firstprivate`, `shared` determine, which variables belong to the data environment of the task
- ➔ Option `if` allows to determine, when an explicit task should be created

2.7.2 The task Directive ...



Example: parallel quicksort (👉 02/qsort.cpp)

```
void quicksort(int *a, int lo, int hi) {
```

```
...
```

```
// Variables are 'firstprivate' by default
```

```
#pragma omp task if (j-lo > 10000)
```

```
quicksort(a, lo, j);
```

```
quicksort(a, i, hi);
```

```
}
```

```
int main() {
```

```
...
```

```
#pragma omp parallel
```

```
#pragma omp single nowait // Execution by a single thread
```

```
quicksort(array, 0, n-1);
```

```
// Before the parallel region ends, we wait for the termination of all threads
```

Task synchronization

```
#pragma omp taskwait
```

```
#pragma omp taskgroup  
{  
    Block  
}
```

- ➔ `taskwait`: waits for the completion of all direct subtasks of the current task
- ➔ `taskgroup`: at the end of the block, the program waits for all subtasks (direct and indirect ones), which the current task has been created within the block
 - ➔ available since OpenMP 4.0
 - ➔ caution: older compilers ignore this directive!



Example: parallel quicksort (👉 02/qsort.cpp)

➔ Changes when calling quicksort:

```
#pragma omp parallel
{
    #pragma omp single nowait // Execution by exactly one thread
    quicksort(array, 0, n-1);
    checkSorted(array, n);
}
```

➔ Problem:

➔ quicksort() starts new tasks

➔ tasks are not yet finished, when quicksort() returns



Example: parallel quicksort ...

➔ Solution 1:

```
void quicksort(int *a, int lo, int hi) {  
    ...  
    #pragma omp task if (j-lo > 10000)  
    quicksort(a, lo, j);  
    quicksort(a, i, hi);  
    #pragma omp taskwait ← wait for the created task  
}
```

- ➔ advantage: subtask finishes, before quicksort() returns
 - ➔ necessary, when there are computations after the recursive call
- ➔ disadvantage: relatively high overhead



Example: parallel quicksort ...

➔ Solution 2:

```
#pragma omp parallel
{
    #pragma omp taskgroup
    {
        #pragma omp single nowait // Execution by exactly one thread
        quicksort(array, 0, n-1);
    }
    checkSorted(array, n);
}
```

← wait for all tasks created in the block

➔ advantage: only wait at one single place

➔ disadvantage: semantics of quicksort() must be very well documented

Dependences between tasks (👉 02/tasks.cpp)

- ➔ Option `depend` allows to specify dependences between tasks
 - ➔ you must specify the affected variables (or array sections, if applicable) and the direction of data flow

➔ Beispiel:

```
#pragma omp task shared(a) depend(out: a)
  a = computeA();
#pragma omp task shared(b) depend(out: b)
  b = computeB();
#pragma omp task shared(a,b,c) depend(in: a,b)
  c = computeCfromAandB(a, b);
#pragma omp task shared(b) depend(out: b)
  b = computeBagain();
```

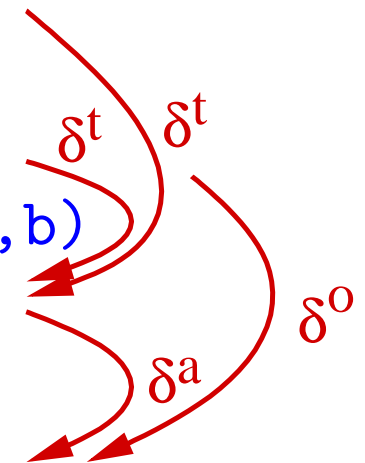

- ➔ the variables `a`, `b`, and `c` must be shared in this case, since they contain the result of the computation of a task

2.8.1 Thread Affinity

- ➔ Goal: control where threads are executed
 - ➔ i.e., by which HW threads on which core on which CPU
- ➔ Important (among others) because of the architecture of today's multicore CPUs
 - ➔ HW threads share the functional units of a core
 - ➔ cores share the L2 caches and the memory interface
- ➔ Concept of OpenMP:
 - ➔ introduction of **places**
 - ➔ place: set of hardware execution environments
 - ➔ e.g., hardware thread, core, processor (socket)
 - ➔ options control the distribution from threads to places

2.8.1 Thread Affinity ...



Environment variable `OMP_PLACES`

- ➔ Defines the places of a computer
- ➔ e.g., nodes with 2 dual-core CPUs with 2 HW threads each:

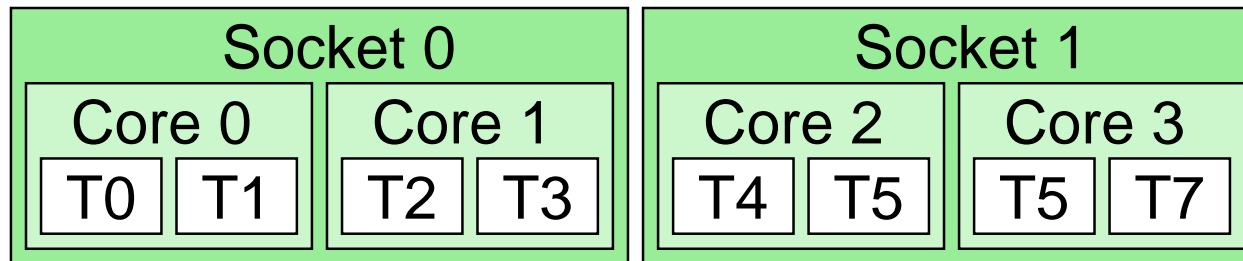

2.8.1 Thread Affinity ...



Environment variable `OMP_PLACES`

- ➔ Defines the places of a computer
- ➔ e.g., nodes with 2 dual-core CPUs with 2 HW threads each:

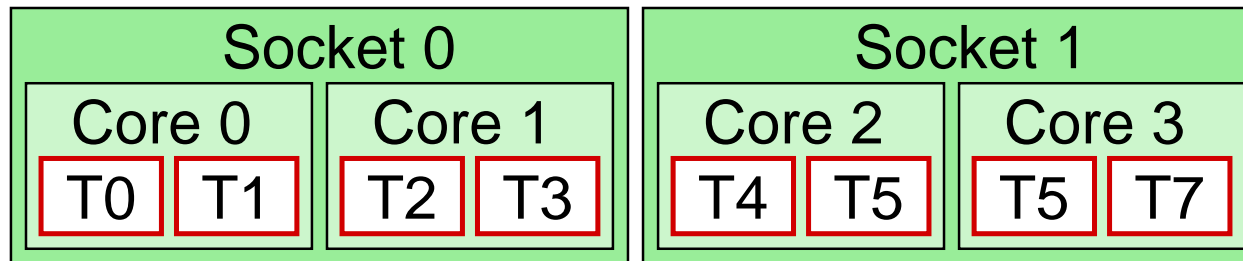

- ➔ To consider each hardware thread as a place, e.g.:

`OMP_PLACES = "threads"`

`OMP_PLACES = "{0},{1},{2},{3},{4},{5},{6},{7}"`

`OMP_PLACES = "{0}:8:1"`

2.8.1 Thread Affinity ...



Environment variable `OMP_PLACES`

- ➔ Defines the places of a computer
- ➔ e.g., nodes with 2 dual-core CPUs with 2 HW threads each:

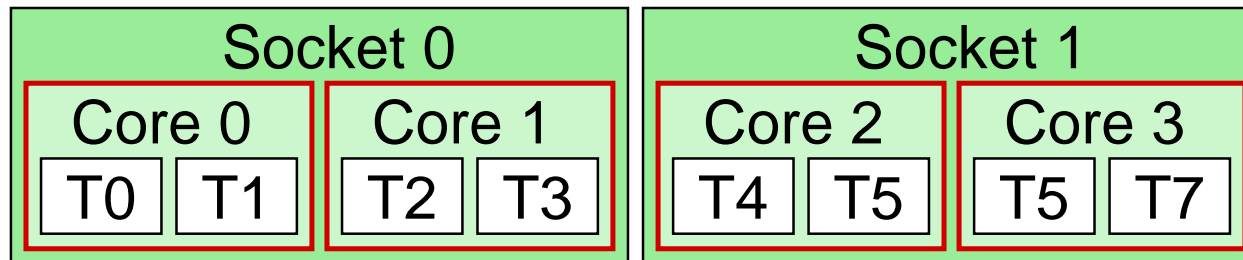

- ➔ To consider each core as a place, e.g.:

`OMP_PLACES = "cores"`

`OMP_PLACES = "{0,1},{2,3},{4,5},{6,7}"`

`OMP_PLACES = "{0,1}:4:2"`

2.8.1 Thread Affinity ...



Environment variable `OMP_PLACES`

- ➔ Defines the places of a computer
- ➔ e.g., nodes with 2 dual-core CPUs with 2 HW threads each:

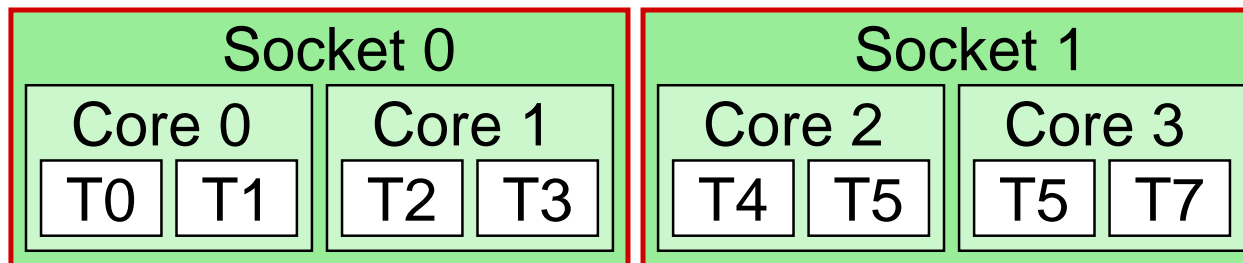

- ➔ To consider each socket as a place, e.g.:
 - `OMP_PLACES = "sockets"`
 - `OMP_PLACES = "sockets(2)"`
 - `OMP_PLACES = "{0:4}, {4:4}"`



Mapping from threads to places

- ➔ Option `proc_bind(spread | close | master)` of the `parallel` directive
 - ➔ `spread`: threads will be evenly distributed to the available places; the list of places will be partitioned
 - ➔ avoids resource conflicts between threads
 - ➔ `close`: threads are allocated as close to the master thread as possible
 - ➔ e.g., to make optimal use of the shared cache
 - ➔ `master`: threads will be allocated on the same place as the master thread
 - ➔ closest possible locality to master thread
- ➔ Usually combined with nested parallel regions

Parallel Processing

WS 2017/18

11.12.2017

Roland Wismüller
Universität Siegen
roland.wismueller@uni-siegen.de
Tel.: 0271/740-4050, Büro: H-B 8404

Stand: January 15, 2018



Example: nested parallel regions

```
double f1(double x)
{
    #pragma omp parallel for proc_bind(close)
    for (i=0; i<N; i++) {
        ...
    }
    ...
    #pragma omp parallel proc_bind(spread)
    #pragma omp single
    {
        #pragma omp task shared(a)
        a = f1(x);
        #pragma omp task shared(b)
        b = f1(y);
    }
    ...
}
```

2.8.1 Thread Affinity ...



Example: nested parallel regions ...

- ➔ Allow nested parallelism: `export OMP_NESTED=true`
- ➔ Define the number of threads for each nesting level:
 - ➔ `export OMP_NUM_THREADS=2,4`
- ➔ Define the places: `export OMP_PLACES=cores`
- ➔ Allow the binding of threads to places:
 - ➔ `export OMP_PROC_BIND=true`

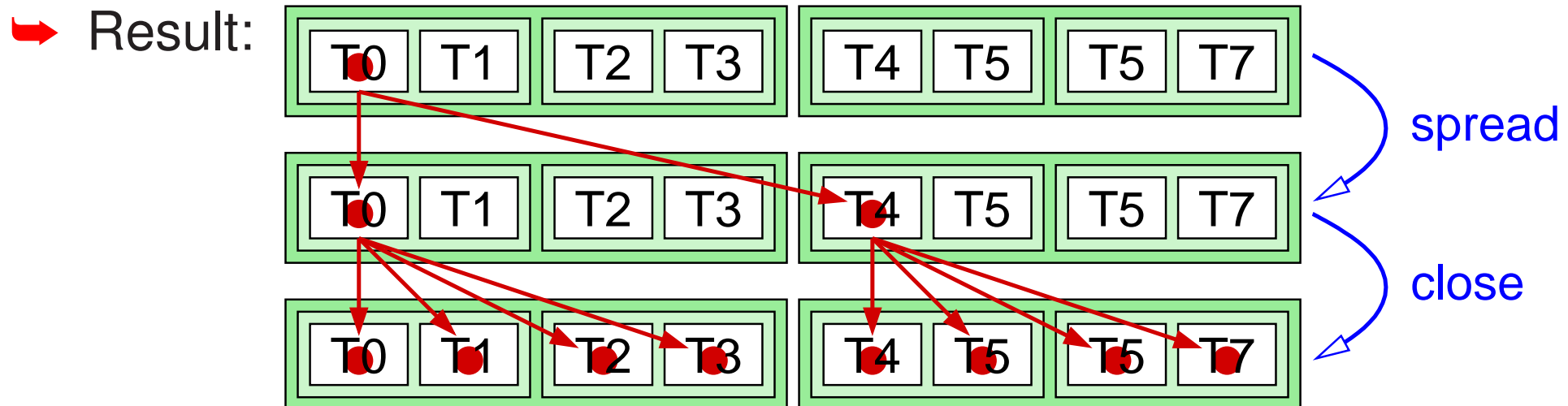

2.8.2 SIMD Vectorization

```
#pragma omp simd [<clause_list>]  
for(...) ...
```

- ➔ Restructuring of a loop in order to use the SIMD vector registers
 - ➔ e.g., Intel SSE: 4 float operations in parallel
- ➔ Loop will be executed by a single thread
 - ➔ combination with for is possible
- ➔ Options (among others): private, lastprivate, reduction
- ➔ Option safelen: maximum vector length
 - ➔ i.e., distance (in iterations) of data dependences, e.g.:

```
for (i=0; i<N; i++)  
    a[i] = b[i] + a[i-4]; // safelen = 4
```

Example

```
#pragma omp declare simd
float distsq(float x, float y) {
    return (x - y) * (x - y);
}
...
#pragma omp simd reduction(+:s)
for (i=0; i<N; i++) {
    s += distsq(x[i], y[i]);
}
```

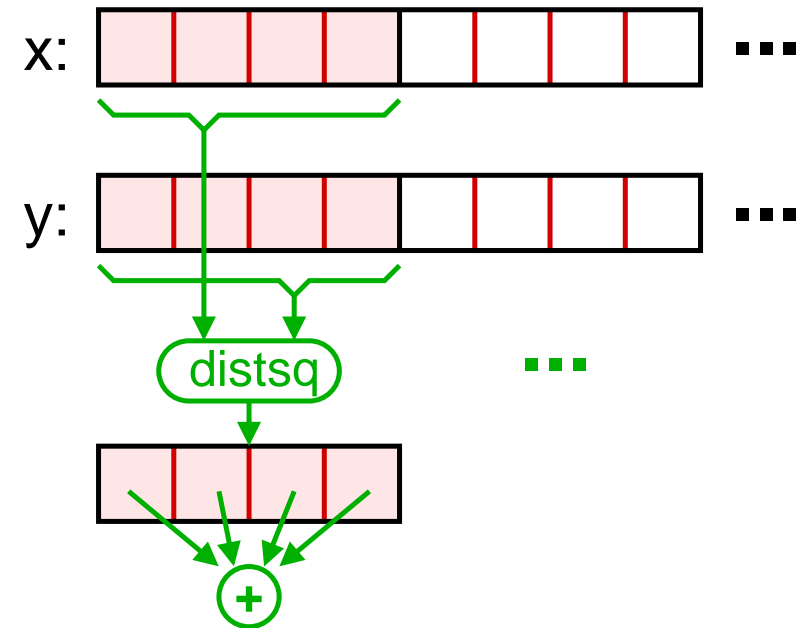

- ➔ The directive `declare simd` generates a version of the function with vector registers as arguments and result
- ➔ For larger `N` the following may be useful:

```
#pragma omp parallel for simd reduction(+:s)
```

2.8.3 Using External Accelerators

- ➔ Model in OpenMP 4.0:
 - ➔ one host (multi processor with shared memory) with several identical accelerators (**targets**)
 - ➔ execution of a code block can be moved to a target using a directive
 - ➔ host and target can have a shared memory, but this is not required
 - ➔ data transport must be executed using directives
- ➔ In order to support the execution model of GPUs:
 - ➔ introduction of thread teams
 - ➔ threads of the same team are executed by one streaming multiprocessor (in SIMD manner)



The `target` directive

```
#pragma omp target [data] [<clause_list>]
```

- ➔ Transfers execution and data to a target
 - ➔ data will be copied between CPU memory and target memory
 - ➔ mapping and direction of transfer are specified using the `map` option
 - ➔ the subsequent code block will be executed on the target
 - ➔ except when only a data environment is created using `target data`
- ➔ Host waits until the computation on the target is finished
 - ➔ however, the `target` directive is also possible within an asynchronous task



The map option

- ➔ Maps variable v_H in the host data environment to the corresponding variable v_T in the target data environment
 - ➔ either the data is copied between v_H and v_T or v_H and v_T are identical
- ➔ Syntax: `map(alloc | to | from | tofrom : <list>)`
 - ➔ `<list>`: list of the original variables
 - ➔ array sections are allowed, too,  [2.7.2](#)
 - ➔ `alloc`: just allocate memory for v_T
 - ➔ `to`: allocate v_T , copy v_H to v_T at the beginning
 - ➔ `from`: allocate v_T , copy v_T to v_H at the end
 - ➔ `tofrom`: default value, `to` and `from`

Target data environment

➔ Course of actions for the target construct:

```
#pragma omp target \  
    map(tofrom: pA)  
{  
    ① ②  
    ... ③  
}  
④ ⑤
```

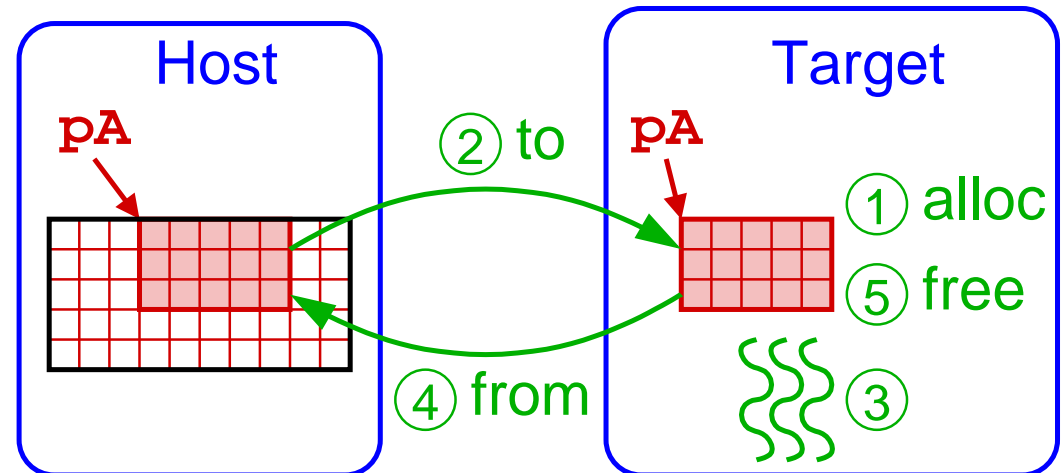

- ➔ target data environments are used to optimize memory transfers
- ➔ several code blocks can be executed on the target, without having to transfer the data several times
 - ➔ if needed, the directive `target update` allows a data transfer within the target data environment



Example

```
#pragma omp target data map(alloc:tmp[:N]) \  
    map(to:in[:N]) map(from:res) } Host  
{  
    #pragma omp target  
    #pragma omp parallel for  
    for (i=0; i<N; i++) } Target  
        tmp[i] = compute_1(in[i]);  
  
    modify_input_array(in); } Host  
  
    #pragma omp target update to(in[:N])  
    #pragma omp target  
    #pragma omp parallel for reduction(+:res)  
    for (i=0; i<N; i++) } Target  
        res += compute_2(in[i], tmp[i])  
}  
} Host
```



Thread teams

➔ Allow a parallelization at two levels, e.g., on GPUs

➔ Create a set of thread teams:

```
#pragma omp teams [<clause_list>]
Statement/Block
```

➔ statement/block is executed by the master thread of each team

➔ teams can **not** synchronize

➔ Distribution of a loop to the master threads of the teams:

```
#pragma omp distribute [<clause_list>]
for(...) ...
```

➔ Parallelization within a team, e.g., using `parallel for`



Example: SAXPY

➔ On the host:

```
void saxpy(float *y, float *x, float a, int n) {  
    #pragma omp parallel for  
    for (int i = 0; i < n; i++)  
        y[i] = a*x[i] + y[i];  
}
```

➔ On the GPU (naive):

```
void saxpy(float *y, float *x, float a, int n) {  
    #pragma omp target map(to:x[0:n], n, a) map(y[0:n])  
    {  
        #pragma omp parallel for  
        for (int i = 0; i < n; i++)  
            y[i] = a*x[i] + y[i];  
    }  
}
```



Example: SAXPY ...

➔ On the GPU (optimized): each team processes a block

```
void saxpy(float *y, float *x, float a, int n) {
    int nBlk = numBlocks(n); // Number of blocks
    int nThr = numThreads(n); // Number of threads
    #pragma omp target map(to:x[0:n], n, a) map(y[0:n])
    #pragma omp teams num_teams(nBlk) thread_limit(nThr)
    {
        #pragma omp distribute
        for (int i = 0; i < n; i += n/nBlk) {
            #pragma omp parallel for
            for (int j = i; j < i + n/nBlk; j++)
                y[j] = a*x[j] + y[j];
        }
    }
}
```



Example: SAXPY ...

➔ On the GPU (optimized, shorter):

```
void saxpy(float *y, float *x, float a, int n) {  
    int nBlk = numBlocks(n); // Number of blocks  
    int nThr = numThreads(n); // Number of threads  
    #pragma omp target map(to:x[0:n], n, a) map(y[0:n])  
    #pragma omp teams distribute parallel for \  
        num_teams(nBlk) thread_limit(nThr)  
    for (int i = 0; i < n; i++)  
        y[i] = a*x[i] + y[i];  
}
```

➔ Iterations are first distributed to the streaming multiprocessors in blocks; there they are again distributed to the individual threads